

tend 卡式組立端子盤

■ 特性

1. 10P以下,免除串接鐵條,2P直接互壓即可,安裝組立方便快捷。(如圖一)
2. 10P以上長度,附加鐵條。20P以上,可分成二段或三段,先固定一段,再加接一段,可不受長度限制加長,且十分堅固。(如圖二)
3. 拆卸時,以一字起子自底面溝槽撬開。(如圖三)
4. TBC-10、TBC-20、TBC-30三種可彼此互相串接,並共用同一鐵條。(如圖四)
5. TBC-60、TBC-100、TBC-200、TBC-300四種亦可互相串接,並共用同一鐵條。(如圖五)
6. TBC-10、20、30可與TBR-60、100、200共同以TBC-N鋁軌組裝,成為軌道式端子盤。(如圖六)
7. TBC-口,口內的數字代表安培數。

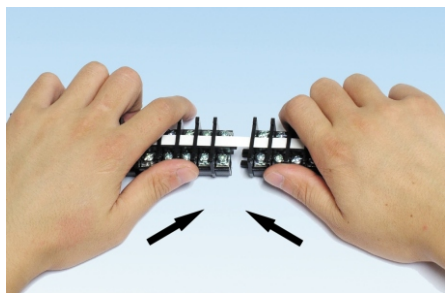

(圖一)

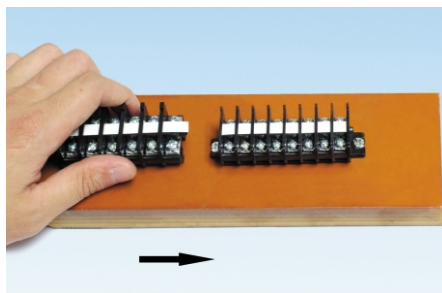

(圖二)



(圖三)

TBC-10.20.30

TBC-60.100.200.300

TBC-10.20.30 TBR-60.100.200

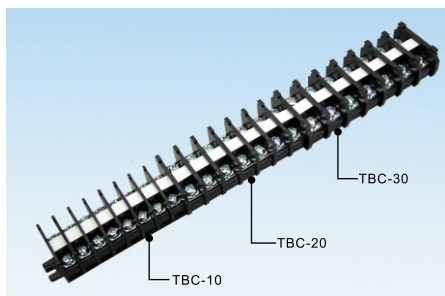

(圖四)

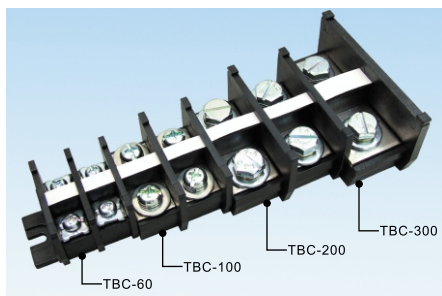

(圖五)

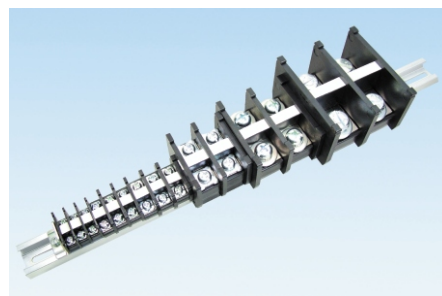

(圖六)

TBR-10C (TBC10、
TBR10端子盤共用)

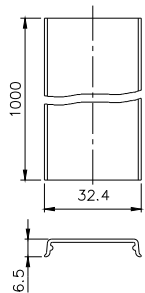
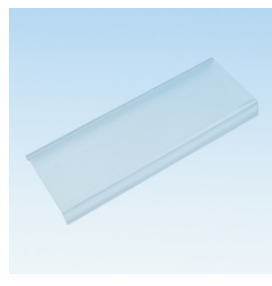

TBR-20C (TBC20、30、TBR20、
30、TBD10、20端子盤共用)

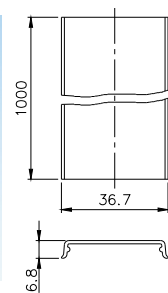

TBR-60C (TBC60、TBR60端子盤共用)

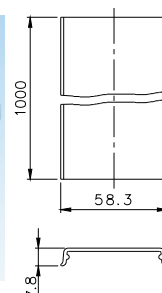
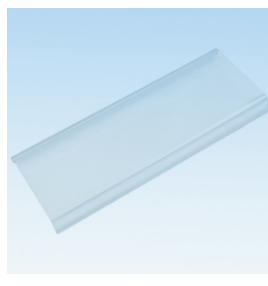

TBC-N

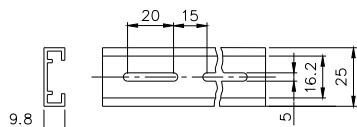
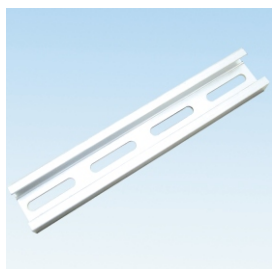

TBC-F

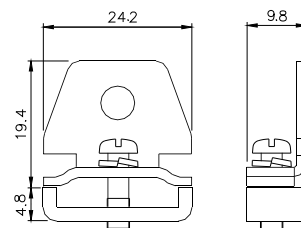

tend 卡式組立端子盤

TBC

■外觀和尺寸

TBC-10

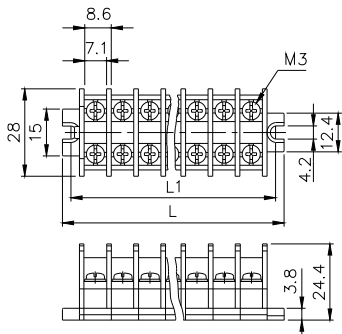

$L=16.8+8.6Xn$
 $L1=10.6+8.6Xn$
 $n=P$ 數

P數	2	3	4	5	6	7	8	9	10	11	12
L	34	42.6	51.2	59.8	68.4	77	85.6	94.2	102.8	111.4	120
L1	27.8	36.4	45	53.6	62.2	70.8	79.4	88	96.6	105.2	113.8

TBC-20

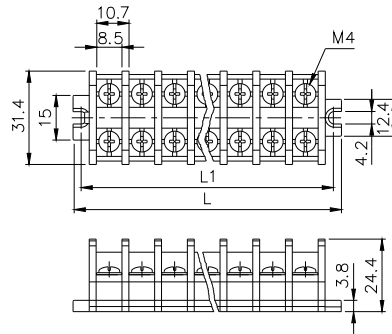

$L=17.6+10.7Xn$
 $L1=11.4+10.7Xn$
 $n=P$ 數

P數	2	3	4	5	6	7	8	9	10	11	12
L	39	49.7	60.4	71.1	81.8	92.5	103.2	113.9	124.6	135.3	146
L1	32.8	43.5	54.2	64.9	75.6	86.3	97	107.7	118.4	129.1	139.8

TBC-30

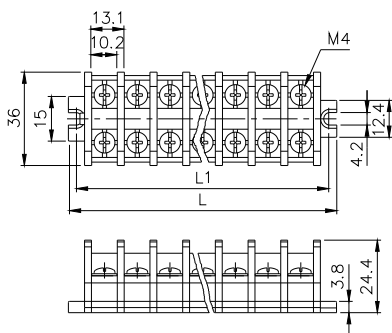

$L=18.1+13.1Xn$
 $L1=11.9+13.1Xn$
 $n=P$ 數

P數	2	3	4	5	6	7	8	9	10	11	12
L	44.3	57.4	70.5	83.6	96.7	109.8	122.9	136	149.1	162.2	175.3
L1	38.1	51.2	64.3	77.4	90.5	103.6	116.7	129.8	142.9	156	169.1

TBC-60

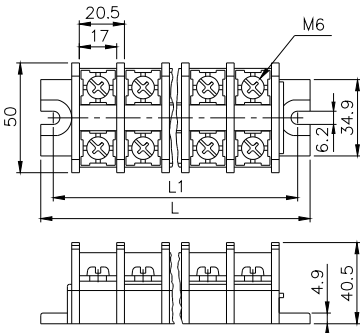

$L=33.3+20.5Xn$
 $L1=17.8+20.5Xn$
 $n=P$ 數

P數	2	3	4	5	6	7	8	9	10	11	12
L	74.3	94.8	115.3	135.8	156.3	176.8	197.3	217.8	238.3	258.8	279.3
L1	58.8	79.3	99.8	120.3	140.8	161.3	181.8	202.3	222.8	243.3	263.8

TBC-100

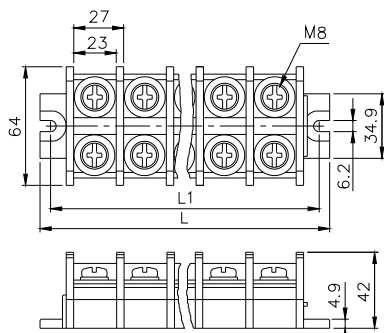
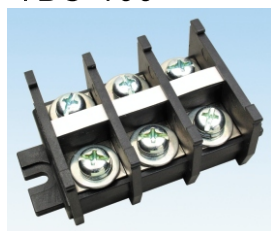

$L=33.8+27Xn$
 $L1=18.4+27Xn$
 $n=P$ 數

P數	2	3	4	5	6	7	8	9	10	11	12
L	87.8	114.8	141.8	168.8	195.8	222.8	249.8	276.8	303.8	330.8	357.8
L1	72.4	99.4	126.4	153.4	180.4	207.4	234.4	261.4	288.4	315.4	342.4

TBC-200

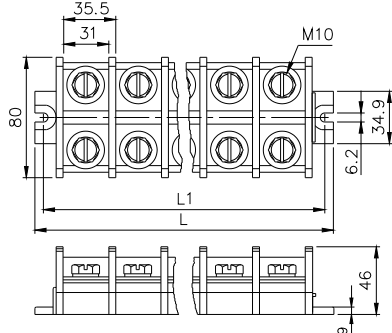

$L=34.4+35.5Xn$
 $L1=19+35.5Xn$
 $n=P$ 數

P數	2	3	4	5	6	7	8	9	10	11	12
L	105.4	140.9	176.4	211.9	247.4	282.9	318.4	353.9	389.4	424.9	460.4
L1	90	125.5	161	196.5	232	267.5	303	338.5	374	409.5	445

TBC-300

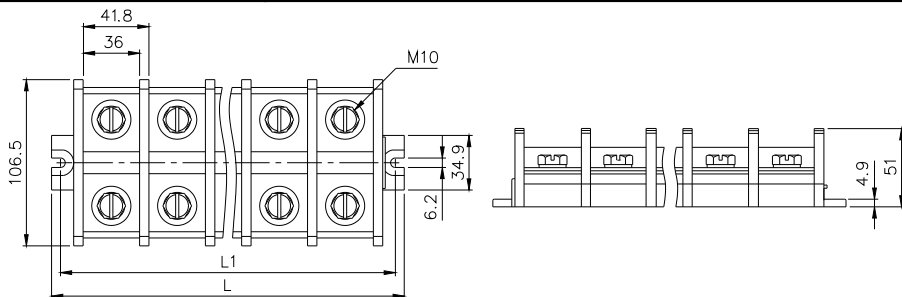
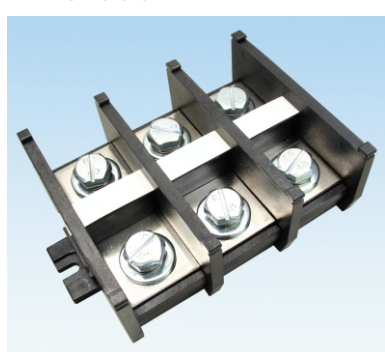

$L=36.5+41.8Xn$
 $L1=21.5+41.8Xn$
 $n=P$ 數

P數	2	3	4	5	6	7	8	9	10	11	12
L	120.1	161.9	203.7	245.5	287.3	329.1	370.9	412.7	454.5	496.3	538.1
L1	105.1	146.9	188.7	230.5	272.3	314.1	355.9	397.7	439.5	481.3	523.1

tend 護蓋卡式端子盤

TBCN

■ 特性

- 本系列護蓋端子盤係將原TBC/TBR/TBD三系列端子盤加以改良設計，原來的透明護蓋需另行購買，且每次拆配線需將護蓋拿開，增加成本及費時。改良後，每只端子盤皆為一體成型護蓋，螺絲起子可直接穿越護蓋上的孔，拆鎖螺絲。確保使用者不會誤觸電源。
- 以往端子盤配線時，需先將螺絲反轉退開，插入端子或電線後再行鎖緊螺絲，新的設計為成品上的螺絲皆不鎖，讓使用者配線時直接鎖緊。且螺絲亦無虞鬆脫時掉落。
- 本系列端子盤另設計加上護套的2P連接片，保護使用者不會誤觸電源。可共同使用於TBCN/TBRN/TBDN三系列產品。
- TBCN-□, □ 內的數字代表安培數。

■ 外觀和尺寸

TBCN-10

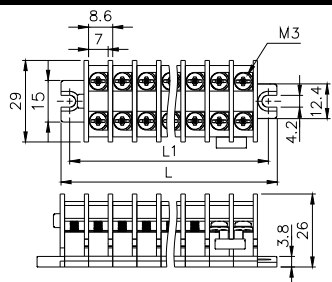

$L=16.8+8.6 \times n$
 $L1=10.6+8.6 \times n$
 $n=P$ 數量

P數量	2	3	4	5	6	7	8	9	10	11	12
L	34	42.6	51.2	59.8	68.4	77	85.6	94.2	102.8	111.4	120
L1	27.8	36.4	45	53.6	62.2	70.8	79.4	88	96.6	105.2	113.8

TBCN-20

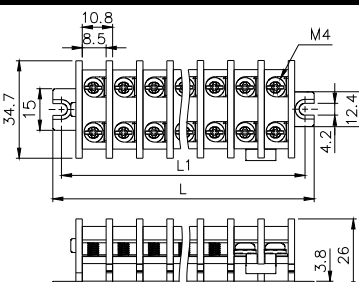

$L=17.6+10.8 \times n$
 $L1=11.4+10.8 \times n$
 $n=P$ 數量

P數量	2	3	4	5	6	7	8	9	10	11	12
L	39.2	50	60.8	71.6	82.4	93.2	104	114.8	125.6	136.4	147.2
L1	33	43.8	54.6	65.4	76.2	87	97.8	108.6	119.4	130.2	141

TBCN-30

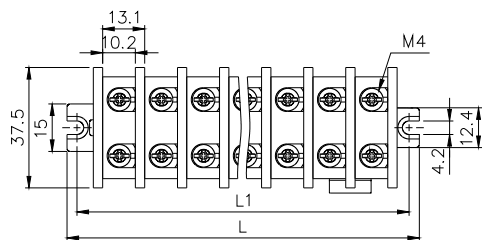

$L=18.1+13.1 \times n$
 $L1=11.9+13.1 \times n$
 $n=P$ 數量

P數量	2	3	4	5	6	7	8	9	10	11	12
L	44.3	57.4	70.5	83.6	96.7	109.8	122.9	136	149.1	162.2	175.3
L1	38.1	51.2	64.3	77.4	90.5	103.6	116.7	129.8	142.9	156	169.1

■ 連接片(TBCN, TBRN, TBDN)

TBCN-10S (10A)

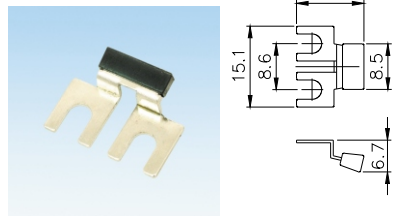

TBCN-20S (20A)

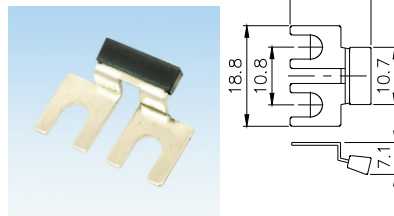

TBCN-30S (30A)

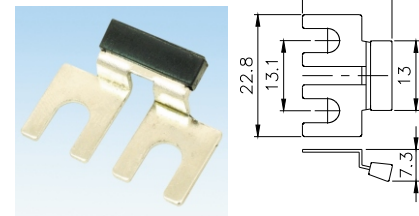

■ 連接片(TBC, TBR, TBD)

TBC-10S-2,3,4,10 (10A)

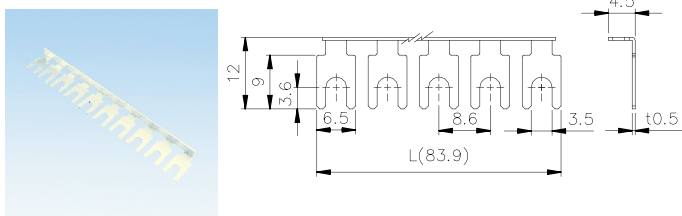

TBC-20S-2,3,4,10 (20A)

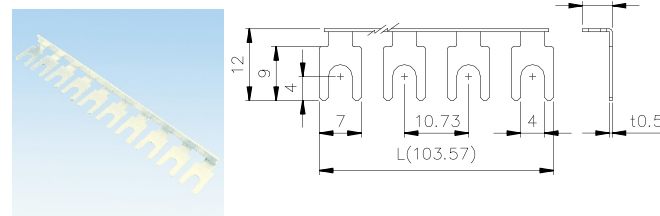

tend 軌道式端子盤

■ 特性

1. 組合時,以端子盤之一端勾住軌道,另一端用力壓即可(如圖一)。
2. 拆卸時,以一字起子插入有溝槽之一端,往外撬起即可拆下(如圖二)。
3. TBR-10、20、30、60、100、200可共用固定於同一支DIN軌道上(TBR-N),二端各以TBR-F固定片扣住,並將固定片上之螺絲鎖緊即可固定(如圖三)。
4. TBR系列並可與繼電器座,限時開關插座共同固定於TBR-N(如圖四)。
5. TBR-60、100、200組裝或拆卸時,由軌道一端穿入或穿出(如圖五)。
6. TBCN-口,口內的數字代表安培數。

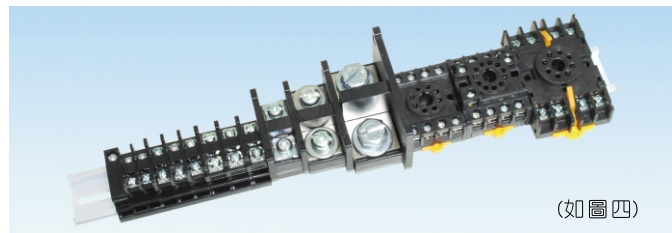
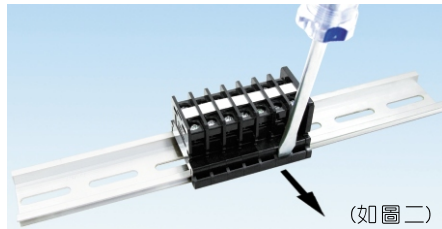

TBR-10

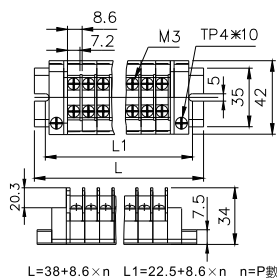

TBR-20

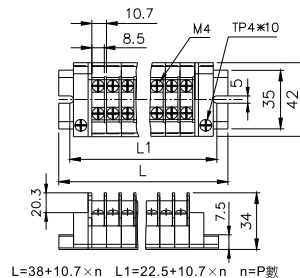
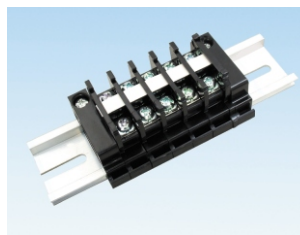

TBR-30

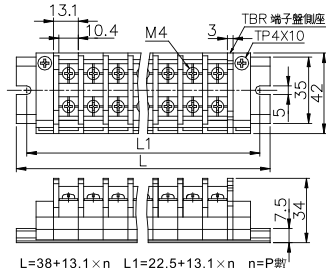
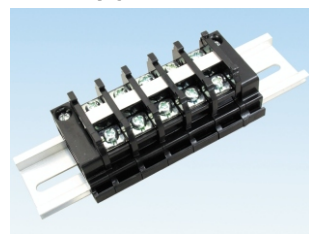

TBR-60

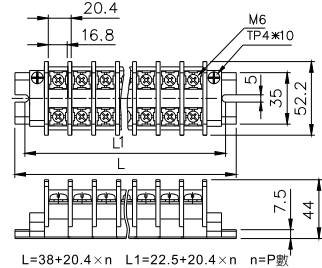
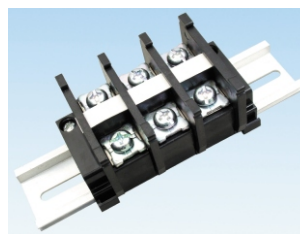

TBR-100

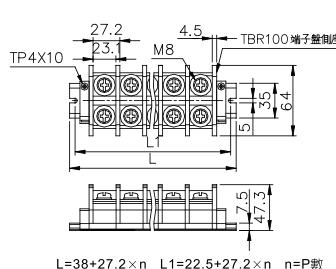
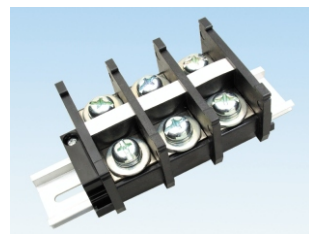

TBR-200

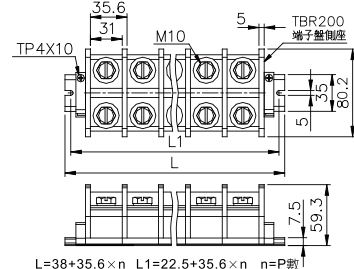

TBS-30 (附彈簧軌道式端子盤)

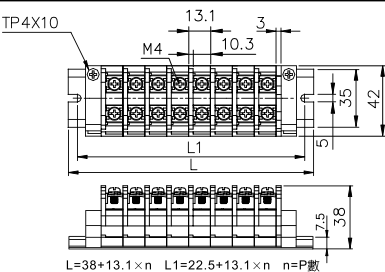

本端子盤為附彈簧式,最適用於O型端子鎖附,不必另拆螺絲,亦無螺絲掉落之顧慮,是指定使用O型端子時的最佳選擇。

tend 護蓋軌道式端子盤

TBRN

TBRN-10

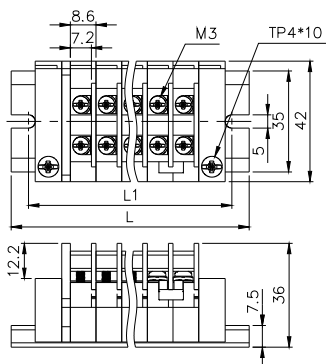
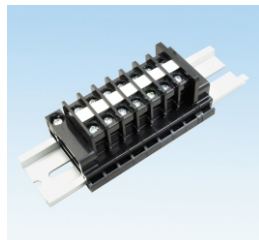

$L=38+8.6 \times n$
 $L1=22.5+8.6 \times n$
 $n=P$ 數量

P數量	2	3	4	5	6	7	8	9	10	11	12
L	55.2	63.8	72.4	81	89.6	98.2	106.8	115.4	124	132.6	141.2
L1	39.7	48.3	56.9	65.5	74.1	82.7	91.3	99.9	108.5	117.1	125.7

TBRN-20

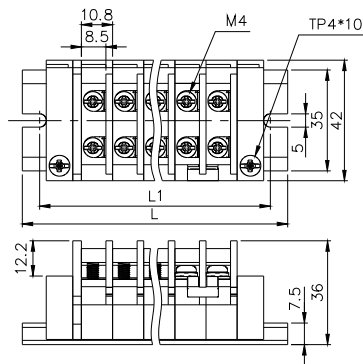
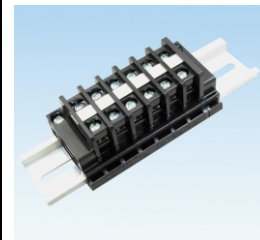

$L=38+10.8 \times n$
 $L1=22.5+10.8 \times n$
 $n=P$ 數量

P數量	2	3	4	5	6	7	8	9	10	11	12
L	59.6	70.4	81.2	92	102.8	113.6	124.4	135.2	146	156.8	167.6
L1	44.1	54.9	65.7	76.5	87.3	98.1	108.9	119.7	130.5	141.3	152.1

TBRN-30

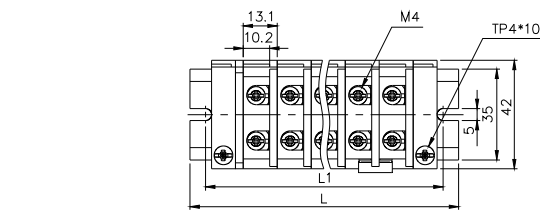

$L=38+13.1 \times n$
 $L1=22.5+13.1 \times n$
 $n=P$ 數量

P數量	2	3	4	5	6	7	8	9	10	11	12
L	64.2	77.3	90.4	103.5	116.6	129.7	142.8	155.9	169	182.1	195.2
L1	48.7	61.8	74.9	88	101.1	114.2	127.3	140.4	153.5	166.6	179.7

TBR-N

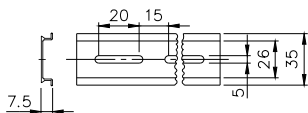
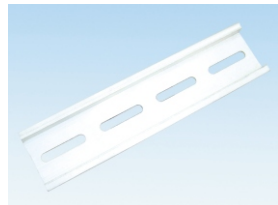

TBR-F

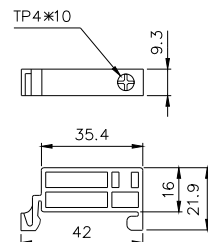
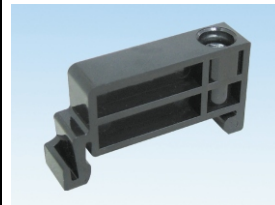

tend 雙層卡式端子盤

TBD

■ 特性

1. 縮短一般端子盤的長度。
2. 有三種組立方式：
 - a. 15P以下直接插入組立，亦可以鐵條穿入中心孔固定。(如圖一)
 - b. 以TBC-N軌道組立，二端以TBC-F固定，裝卸時，皆由軌道之一端穿入及穿出。(如圖二)
 - c. 以TBR-N軌道組立，二端以TBR-F固定，組立時由上往下壓入即可。(如圖三)
3. TBC-N、口內的數字代表安培數。

TBD-10 卡式組立(圖一)

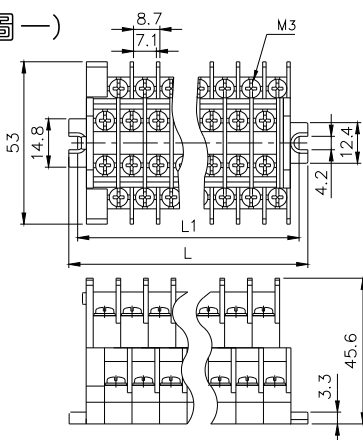
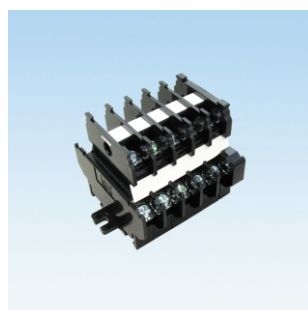

$L=21.5+8.7 \times n$
 $L1=15.1+8.7 \times n$
 $n=P$ 數

P數	2	3	4	5	6	7	8	9	10	11	12
L	38.9	47.6	56.3	65	73.7	82.4	91.1	99.8	108.5	117.2	125.9
L1	32.5	41.2	49.9	58.6	67.3	76	84.7	93.4	102.1	110.8	119.5

TBD-20 卡式組立(圖一)

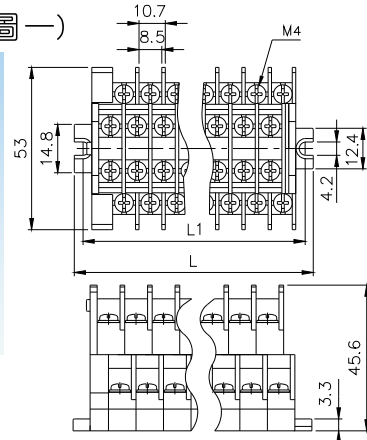
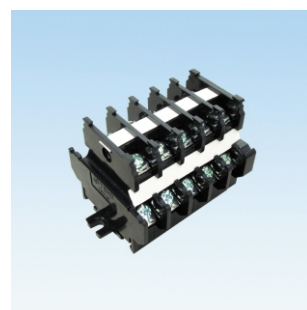

$L=21.5+10.7 \times n$
 $L1=15.1+10.7 \times n$
 $n=P$ 數

P數	2	3	4	5	6	7	8	9	10	11	12
L	42.9	53.6	64.3	75	85.7	96.4	107.1	117.8	128.5	139.2	149.9
L1	36.5	47.2	57.9	68.6	79.3	90	100.7	111.4	122.1	132.8	143.5

tend 雙層卡式端子盤

■外觀和尺寸

TBH-10 卡式組立(圖一)

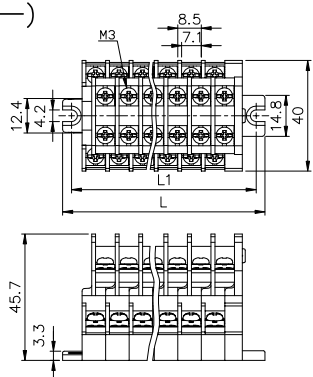

L=21.5+8.5Xn
L1=15.1+8.5Xn
N=P數量

P數	2	3	4	5	6	7	8	9	10	11	12
L	38.5	47	55.5	64	72.5	81	89.5	98	106.5	115	123.5
L1	32.1	40.6	49.1	57.6	66.1	74.6	83.1	91.6	101.1	108.6	117.1

TBDS-20 卡式組立(圖一)

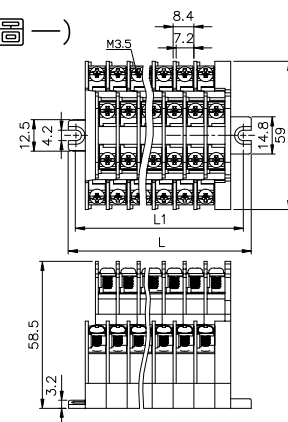

L=21.4+8.4Xn
L1=15.1+8.4Xn
N=P數量

本端子盤為附彈簧式,適用於O型端子鎖附,不必另拆螺絲。

P數	2	3	4	5	6	7	8	9	10	11	12
L	38.2	46.6	55	63.4	71.8	80.2	88.6	97	105.4	113.8	122.2
L1	31.9	40.3	48.7	57.1	65.5	73.9	82.3	90.7	99.1	107.5	115.9

TBC-N軌道組立(圖二)

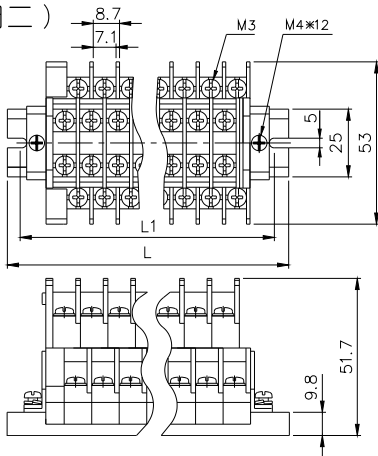
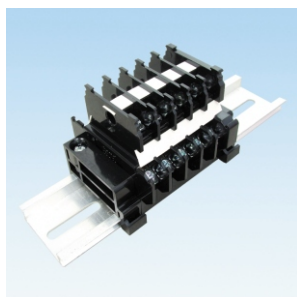

L=38+8.7Xn
L1=22.5+8.7Xn
n=P數

TBR-N軌道組立(圖三)

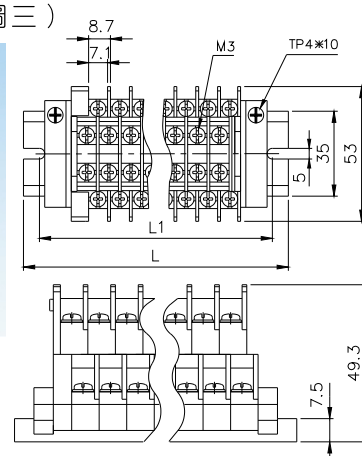
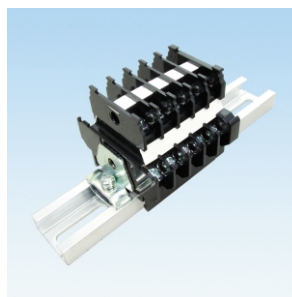

L=38+8.7Xn
L1=22.5+8.7Xn
n=P數

tend 護蓋雙層卡式端子盤

TBDN

■外觀和尺寸

TBDN-10 卡式組立(圖一)

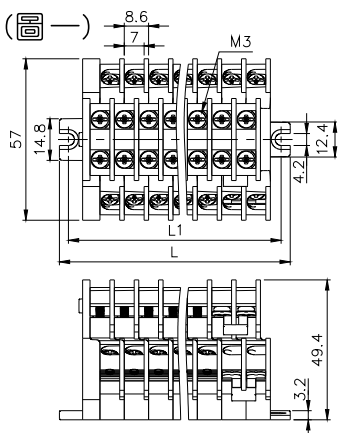

L=21.5+8.6Xn
L1=15.1+8.6Xn
n=P數量

P數	2	3	4	5	6	7	8	9	10	11	12
L	38.7	47.3	55.9	64.5	73.1	81.7	90.3	98.9	107.5	116.1	124.7
L1	32.3	40.9	49.5	58.1	66.7	75.3	83.9	92.5	101.1	109.7	118.3

TBDN-20 卡式組立(圖一)

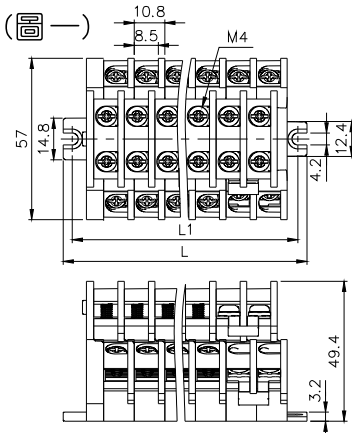

L=21.5+10.8Xn
L1=15.1+10.8Xn
n=P數量

P數	2	3	4	5	6	7	8	9	10	11	12
L	43.1	53.9	64.7	75.5	86.3	97.1	107.9	118.7	129.5	140.3	151.1
L1	36.7	47.5	58.3	69.1	79.9	90.7	101.5	112.3	123.1	133.9	144.7

tend 固定式端子盤

■外觀和尺寸

T20

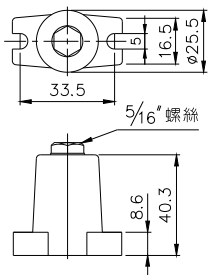

T40

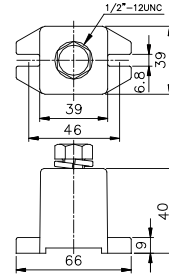

TB-10

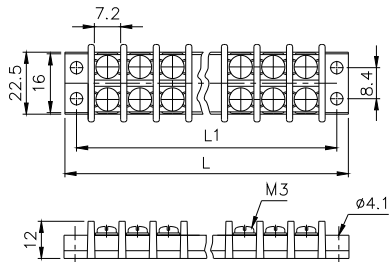

TB-20

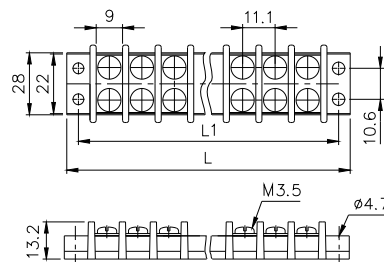
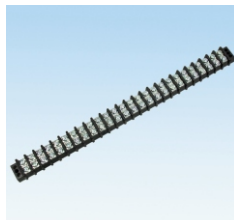

P數	1	2	3	4	5	6	7	8	9	10	11	12	13
L	26.2	35.7	45.2	54.7	64.2	73.7	83.2	92.7	102.2	111.7	121.2	130.7	140.2
L1	19	28.5	38	47.5	57	66.5	76	85.5	95	104.5	114	123.5	133

P數	1	2	3	4	5	6	7	8	9	10	11	12	13
L	31.2	42.3	53.4	64.5	75.6	86.7	97.8	108.9	120	131.1	142.2	153.3	164.4
L1	22.2	33.3	44.4	55.5	66.6	77.7	88.8	99.9	111	122.1	133.2	144.3	155.4

P數	14	15	16	17	18	19	20	21	22	23	24	25	26
L	149.7	159.2	168.7	178.2	187.7	197.2	206.7	216.2	225.7	235.2	244.7	254.2	263.7
L1	142.5	152	161.5	171	180.5	190	199.5	209	218.5	228	237.5	247	256.5

P數	14	15	16	17	18	19	20	21	22	23	24	25	26
L	175.5	186.6	197.7	208.8	219.9	231	242.1	253.2	264.3	275.4	286.5	297.6	308.7
L1	166.5	177.6	188.7	199.8	210.9	222	233.1	244.2	255.3	266.4	277.5	288.6	299.7

TB15-3

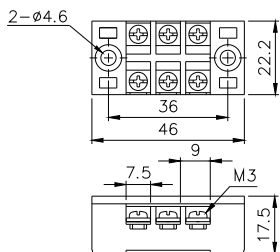

TB15-4

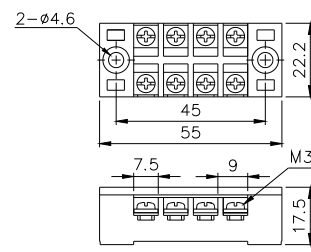

TB15-6

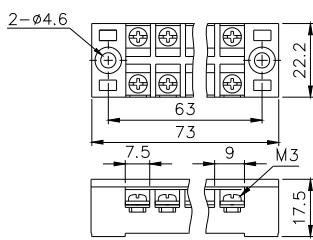

TB15-12

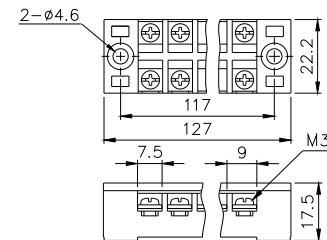

TB25-3

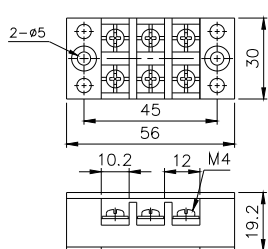

TB25-4

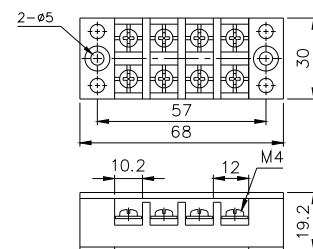
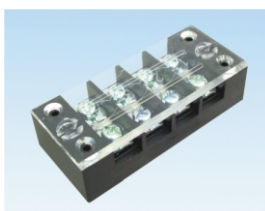

TB25-6

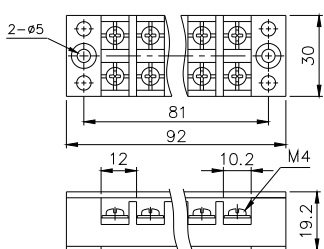
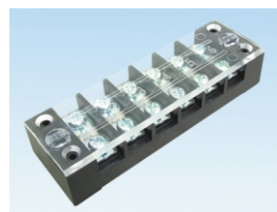

TB25-12

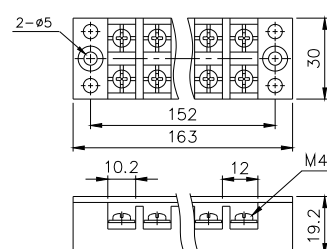
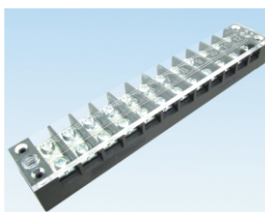

tend 護蓋固定式端子盤

TB

■ 特性

組裝時無須使護蓋與基座分開，亦無需退開螺絲，即可將螺絲起子直接穿過護蓋上的通孔，旋緊基座上的螺絲，以增進配線作業的方便性。

■ 外觀和尺寸

TB15-3N

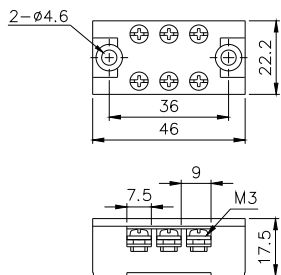

TB15-4N

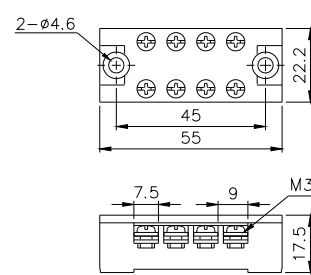
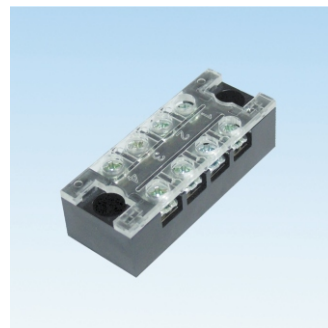

TB15-6N

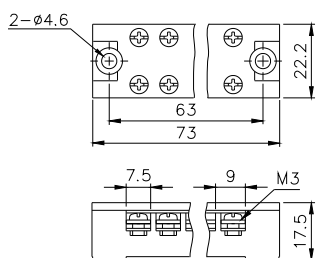

TB15-12N

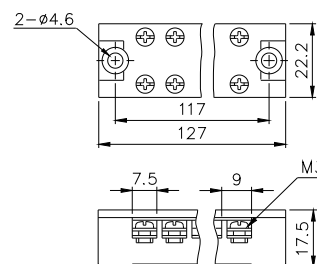

■ 外觀和尺寸

TB25-3N

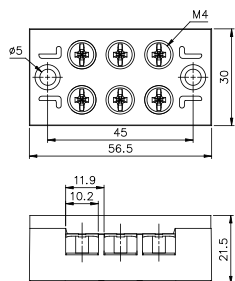

TB25-4N

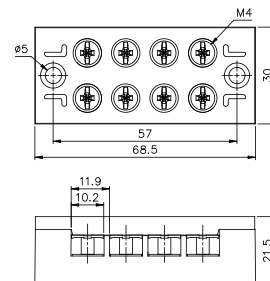

TB25-6N

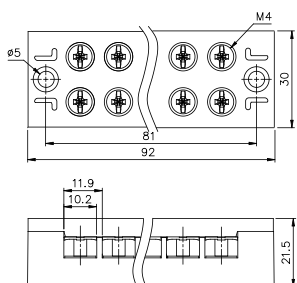

TB25-12N

