

# tend 軌道式端子盤

TBU

## ■ 特徵

- TBU系列的端子盤可配在TBR-N及TBU-N兩種導軌上。
- 採用框式壓線,材料為經淬火硬化並經鍍鋅鈍化的優質鋼板。
- 可搭配適合的短路片及標示牌,產品的設計符合IEC60947-7-1等國際標準。



TBU-2.5N

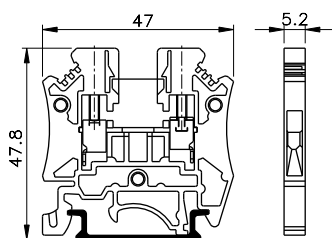
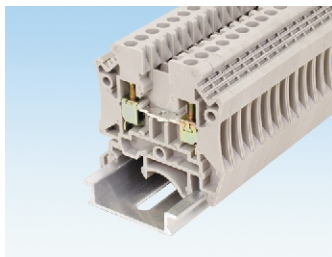

TBU-4N

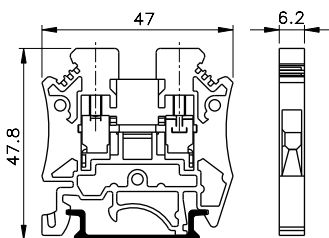
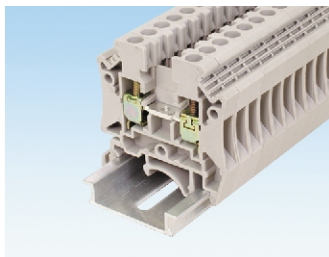



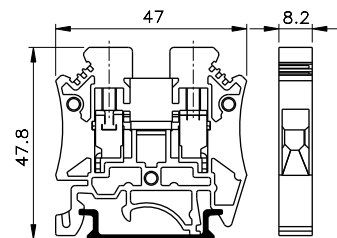
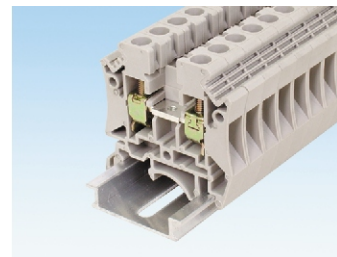









TBU-6N



## 規格

規格	IEC	IEC	IEC
額定電流	24A	32A	41A
額定電壓	800V	800V	800V
電線截面積	2.5mm <sup>2</sup>	4mm <sup>2</sup>	6mm <sup>2</sup>
單芯線	22-12AWG	22-10AWG	20-8 AWG
多芯線	22-12AWG	22-10AWG	20-8 AWG
耐電壓	5KV	5KV	5KV
扭力	4kgf.cm	6kgf.cm	10kgf.cm
螺絲	M2.6	M3	M3.5
剝線長度	10~12mm	10~12mm	10~12mm

## 配件

配件	型號	包裝數	型號	包裝數	型號	包裝數
標示牌 	TBU2.5N-A	100	TBU4N-A	100	TBU6N-A	100
擋片 	TBU2.5N-F	50	TBU2.5N-F	50	TBU2.5N-F	50
側蓋 	TBU2.5N-H	100	TBU2.5N-H	100	TBU2.5N-H	100
適用導軌 	TBR-N(鋁)/TBR-S(鋼)	1M/條	TBR-N(鋁)/TBR-S(鋼)	1M/條	TBR-N(鋁)/TBR-S(鋼)	1M/條
上連接片 	TBU2.5N-CU2	2P 50	TBU4N-CU2	2P 50	TBU6N-CU2	2P 50
	TBU2.5N-CU3	3P 50	TBU4N-CU3	3P 50	TBU6N-CU3	3P 50
	TBU2.5N-CU4	4P 50	TBU4N-CU4	4P 50	TBU6N-CU4	4P 50
	TBU2.5N-CU10	10P 20	TBU4N-CU10	10P 20	TBU6N-CU10	10P 20
側連接片 	TBU2.5N-CS2	2P 50	TBU4N-CS2	2P 50	TBU6N-CS2	2P 50
	TBU2.5N-CS3	3P 50	TBU4N-CS3	3P 50	TBU6N-CS3	3P 50
	TBU2.5N-CS4	4P 50	TBU4N-CS4	4P 50	TBU6N-CS4	4P 50
	TBU2.5N-CS10	10P 20	TBU4N-CS10	10P 20	TBU6N-CS10	10P 20

# tend 軌道式端子盤

TBU

TBU-10N

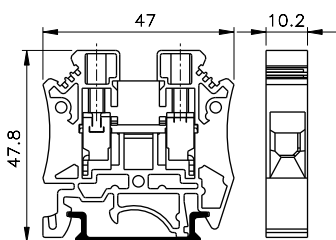
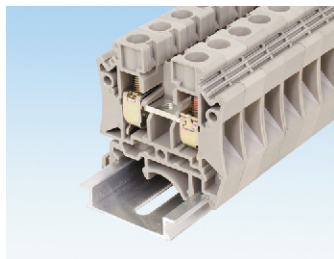

TBU-16N

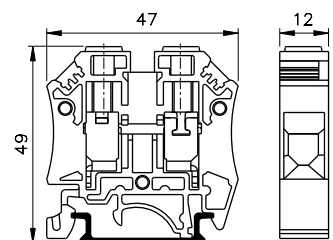
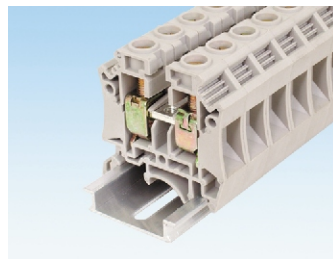

TBU-35N

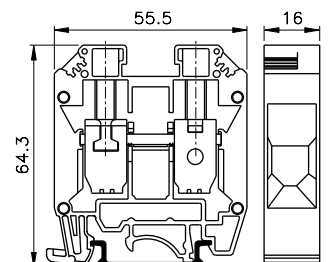
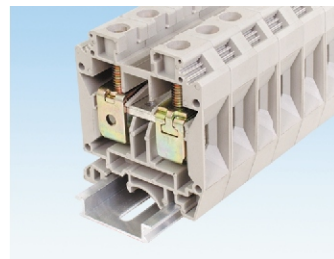

TBU-50N

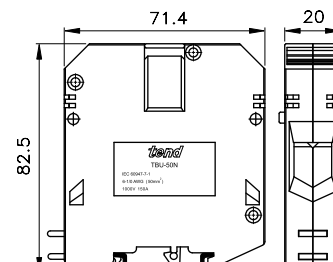
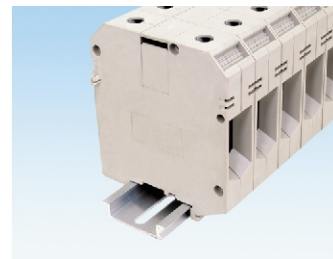

IEC
57A
800V
10mm <sup>2</sup>
16-6 AWG
16-6 AWG
5KV
16kgf.cm
M4
10~12mm

IEC
76A
800V
16mm <sup>2</sup>
14-6AWG
14-6AWG
5KV
30kgf.cm
M5
10~12mm

IEC
125A
800V
35mm <sup>2</sup>
12-2AWG
12-2AWG
5KV
50kgf.cm
M6
15~20mm

IEC
150A
1000V
50mm <sup>2</sup>
6-1/0AWG
6-1/0AWG
5KV
50kgf.cm
M6
25~30mm

型號	包裝數
TBU10N-A	100
TBU2.5N-F	50
TBU2.5N-H	100
TBR-N(鋁)/TBR-S(鋼)	1M/條
TBU10N-CU2 2P	50
TBU10N-CU3 3P	50
TBU10N-CU4 4P	50
TBU10N-CU10 10P	20
TBU10N-CS2 2P	50
TBU10N-CS3 3P	50
TBU10N-CS4 4P	50
TBU10N-CS10 10P	20

型號	包裝數
TBU10N-A	100
TBU2.5N-F	50
TBU2.5N-H	100
TBR-N(鋁)/TBR-S(鋼)	1M/條
TBU16N-CU2 2P	50
TBU16N-CU3 3P	50
TBU16N-CU4 4P	50
TBU16N-CU10 10P	10
TBU16N-CS2 2P	50
TBU16N-CS3 3P	50
TBU16N-CS4 4P	50
TBU16N-CS10 10P	10

型號	包裝數
TBU10N-A	100
TBU35N-F	50
TBU35N-H	50
TBR-N(鋁)/TBR-S(鋼)	1M/條
TBU35N-CU2 2P	50
TBU35N-CU3 3P	50
TBU35N-CU4 4P	50
TBU35N-CU10 10P	10
TBU35N-CS2 2P	50
TBU35N-CS3 3P	50
TBU35N-CS4 4P	50
TBU35N-CS10 10P	10

型號	包裝數
TBU50N-A	50
TBU35N-F	50
TBR-N(鋁)/TBR-S(鋼)	1M/條

# tend 軌道式端子盤

TBU

## ■ 特徵

- TBU&TBE系列的端子盤可配在 TBR-N 及 TBU-N兩種導軌上。
- 採用框式壓線,材料為經淬火硬化並經鍍鋅鈍化的優質鋼板。
- 可搭配適合的短路片及標示牌,產品的設計符合IEC60947-7-1等國際標準。

TBU-70N

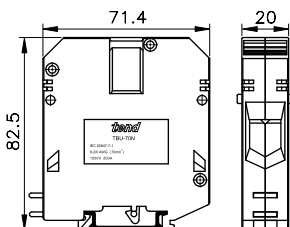
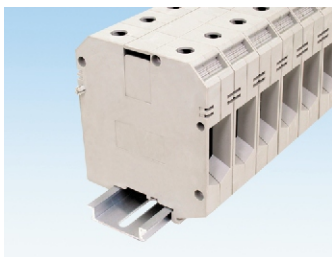

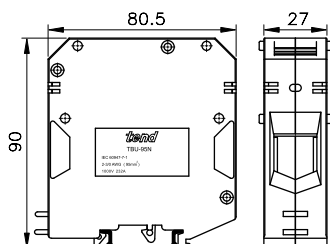
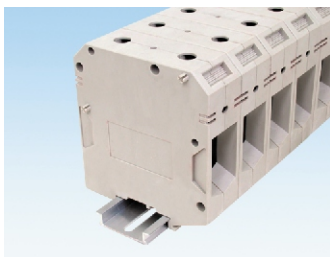

TBU-95N

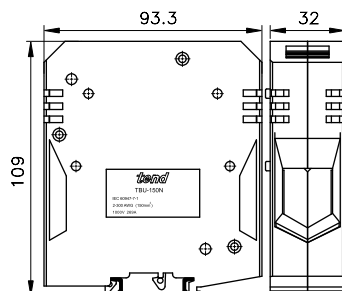
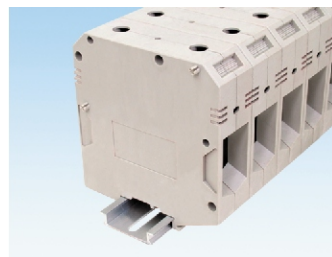

TBU-150N



規格	IEC		IEC		IEC	
額定電流	200A		232A		269A	
額定電壓	1000V		1000V		1000V	
電線截面積	70mm <sup>2</sup>		95mm <sup>2</sup>		150mm <sup>2</sup>	
單芯線	6-2/0 AWG		2-3/0AWG		2-300AWG	
多芯線	6-2/0 AWG		2-3/0AWG		2-300AWG	
耐電壓	5KV		5KV		5KV	
扭力	50kgf.cm		90kgf.cm		165kgf.cm	
螺絲	M6		M8		M10	
剝線長度	25~30mm		30~35mm		35~40mm	
配件	型號	包裝數	型號	包裝數	型號	包裝數
標示牌 	TBU50N-A	50	TBU50N-A	50	TBU50N-A	50
擋片 	TBU35N-F	50	TBU35N-F	50	TBU35N-F	50
適用導軌 	TBR-N(鋁)/TBR-S(鋼)	1M/條	TBR-N(鋁)/TBR-S(鋼)	1M/條	TBR-N(鋁)/TBR-S(鋼)	1M/條

# tend 軌道式接地端子盤

TBE

## ■ 特徵

- TBE系列的端子盤可配在TBR-N及TBU-N兩種導軌上。
- 採用框式壓線,材料為經淬火硬化並經鍍鋅鈍化的優質鋼板。
- 可搭配適合的短路片及標示牌,產品的設計符合IEC60947-7-2等國際標準。

TBE-2.5N

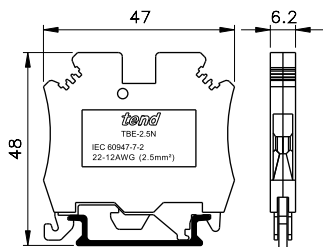
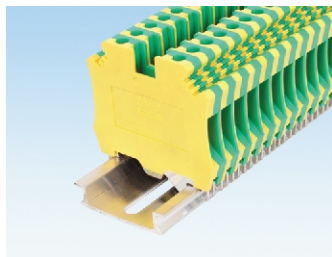

TBE-4N

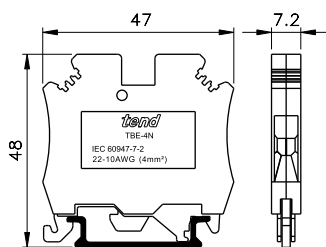
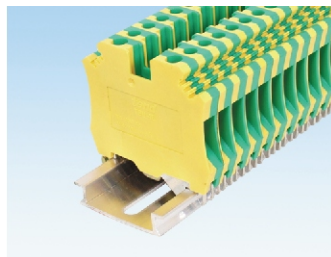

TBE-6N

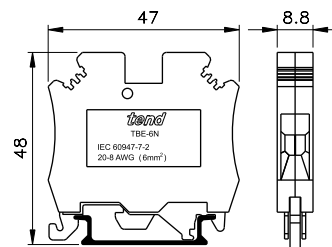

規格	IEC		IEC		IEC	
額定電流	24A		32A		41A	
電線截面積	2.5mm <sup>2</sup>		4mm <sup>2</sup>		6mm <sup>2</sup>	
單芯線	22-12AWG		22-10AWG		20-8 AWG	
多芯線	22-12AWG		22-10AWG		20-8 AWG	
耐電壓	5KV		5KV		5KV	
扭力	4kgf.cm		6kgf.cm		10kgf.cm	
螺絲	M2.6		M3		M3.5	
剝線長度	10~12mm		10~12mm		10~12mm	
配件	型號	包裝數	型號	包裝數	型號	包裝數
標示牌	TBU4N-A	100	TBU4N-A	100	TBU6N-A	100
擋片	TBU2.5N-F	50	TBU2.5N-F	50	TBU2.5N-F	50
適用導軌	TBR-N(鋁)/TBR-S(鋼)	1M/條	TBR-N(鋁)/TBR-S(鋼)	1M/條	TBR-N(鋁)/TBR-S(鋼)	1M/條

# tend 軌道式接地端子盤

TBE

## ■ 特徵

- TBE系列的端子盤可配在TBR-N及TBU-N兩種導軌上。
- 採用框式壓線,材料為經淬火硬化並經鍍鋅鈍化的優質鋼板。
- 可搭配適合的短路片及標示牌,產品的設計符合IEC60947-7-2等國際標準。

TBE-10N

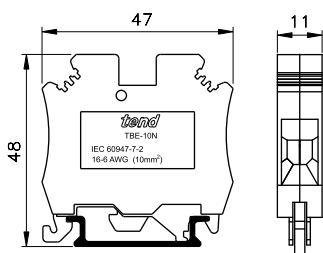

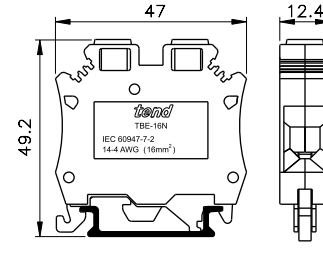
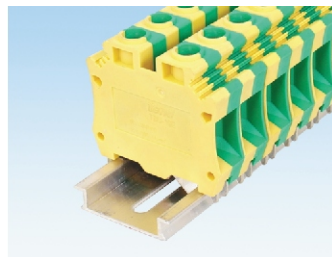

TBE-16N

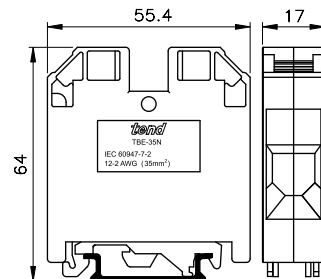
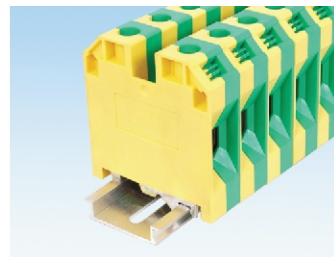

TBE-35N



規格	IEC		IEC		IEC	
額定電流	57A		76A		125A	
電線截面積	10mm <sup>2</sup>		16mm <sup>2</sup>		35mm <sup>2</sup>	
單芯線	16-6AWG		14-6AWG		12-2AWG	
多芯線	16-6 AWG		14-6AWG		12-2AWG	
耐電壓	5KV		5KV		5KV	
扭力	16kgf.cm		30kgf.cm		50kgf.cm	
螺絲	M4		M5		M6	
剝線長度	10~12mm		10~12mm		15~20mm	
配件	型號	包裝數	型號	包裝數	型號	包裝數
標示牌 	TBU10N-A	100	TBU10N-A	100	TBU10N-A	100
擋片 	TBU2.5N-F	50	TBU2.5N-F	50	TBU35N-F	50
適用導軌 	TBR-N(鋁)/TBR-S(鋼)	1M/條	TBR-N(鋁)/TBR-S(鋼)	1M/條	TBR-N(鋁)/TBR-S(鋼)	1M/條

# tend 軌道式接地端子盤

TBE

TBE-50N

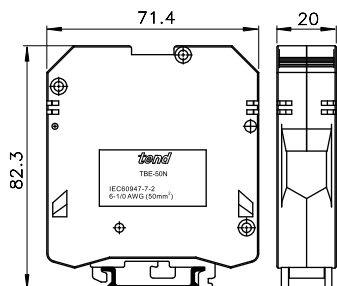
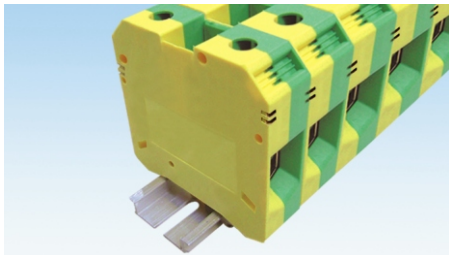

TBE-70N

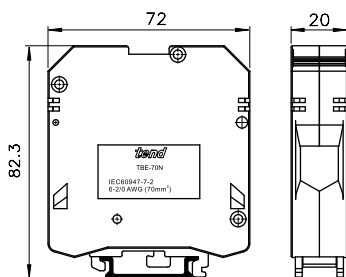
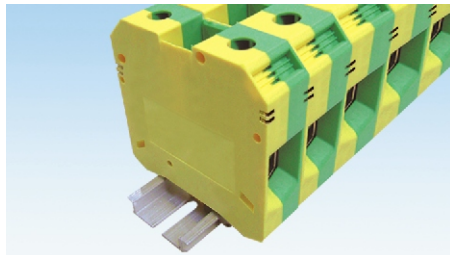

TBE-95N

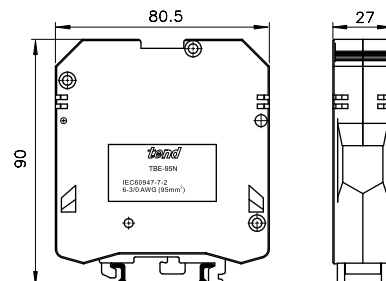
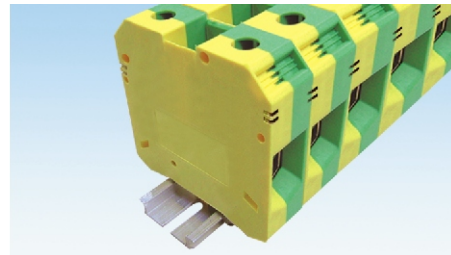

IEC
150A
50mm <sup>2</sup>
6-1/0AWG
6-1/0AWG
5KV
50kgf.cm
M6
25~30mm

IEC
200A
70mm <sup>2</sup>
6-2/0 AWG
6-2/0 AWG
5KV
50kgf.cm
M6
25~30mm

IEC
232A
95mm <sup>2</sup>
2-3/0AWG
2-3/0AWG
5KV
90kgf.cm
M8
30~35mm

型號	包裝數
----	-----

TBU50N-A	50
TBU35N-F	50
TBR-N(鋁)/TBR-S(鋼)	1M/條

型號	包裝數
----	-----

TBU50N-A	50
TBU35N-F	50
TBR-N(鋁)/TBR-S(鋼)	1M/條

型號	包裝數
----	-----

TBU50N-A	50
TBU35N-F	50
TBR-N(鋁)/TBR-S(鋼)	1M/條

# tend 軌道式端子盤

TBT

## ■ 特徵

- TBT閘刀式及TBFV(H)系列的保險絲端子盤可裝配在TBR-N及TBU-N兩種導軌上。
- 採用框式壓線,材料為經淬火硬化並經鍍鋅鈍化的優質鋼板。
- 可搭配適合的標示牌,產品的設計符合IEC60947-7-3等國際標準。

TBT-2.5N(閘刀式)

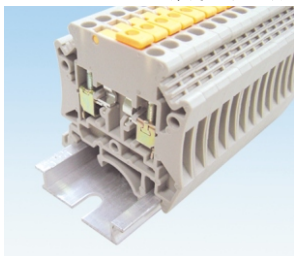

TBT-4N(閘刀式)

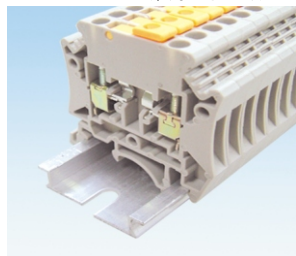
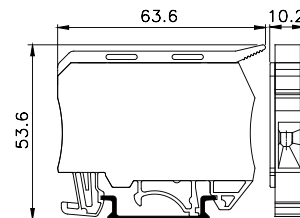
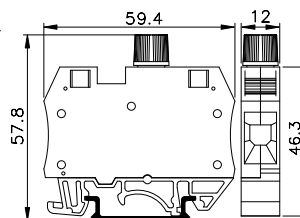
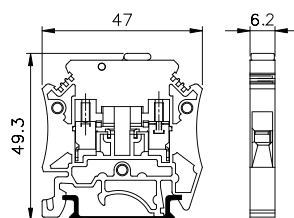
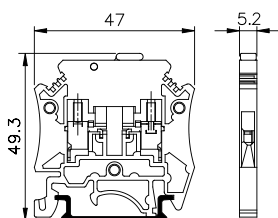
TBFV(立式保險絲)  
TBFV-1/TBFV-2(附LED)TBFH(臥式保險絲)  
TBFH-1/TBFH-2(附LED)

規格	IEC		IEC		IEC		IEC	
額定電流	10A		16A		10A		6.3A	
額定電壓	400V		400V		500V		400V	
電線截面積	2.5mm <sup>2</sup>		4mm <sup>2</sup>		10mm <sup>2</sup>		4mm <sup>2</sup>	
單芯線	22-12AWG		22-10AWG		16-6AWG		22-10AWG	
多芯線	22-12AWG		22-10AWG		16-6AWG		22-10AWG	
耐電壓	5KV		5KV		5KV		5KV	
扭力	4kgf.cm		6kgf.cm		16kgf.cm		6kgf.cm	
螺絲	M2.6		M3		M4		M3	
剝線長度	10~12mm		10~12mm		10~12mm		10~12mm	
保險絲規格	——		——		Ø5X20		Ø5X20/Ø5X25	
配件	型號	包裝數	型號	包裝數	型號	包裝數	型號	包裝數
標示牌	TBU2.5N-A	100	TBU4N-A	100	TBU10N-A	100	TBU6N-A	100
擋片	TBU2.5N-F	50	TBU2.5N-F	50	TBU2.5N-F	50	TBU2.5N-F	50
側蓋	TBU2.5N-H	100	TBU2.5N-H	100	——	——	——	——
適用導軌	TBR-N(鋁)/TBR-S(鋼)1M/條		TBR-N(鋁)/TBR-S(鋼)1M/條		TBR-N(鋁)/TBR-S(鋼)1M/條		TBR-N(鋁)/TBR-S(鋼)1M/條	
上連接片	——		——		TBU16N-CU2	2P 50	——	
	——		——		TBU16N-CU3	3P 50	——	
側連接片	TBU2.5N-CS2	2P 50	TBU4N-CS2	2P 50	TBU16N-CS2	2P 50	——	
	TBU2.5N-CS3	3P 50	TBU4N-CS3	3P 50	TBU16N-CS3	3P 50	——	
	TBU2.5N-CS4	4P 50	TBU4N-CS4	4P 50	TBU16N-CS4	4P 50	——	
	TBU2.5N-CS10	10P 20	TBU4N-CS10	10P 20	TBU16N-CS10	10P 10	——	
規格	說 明							
附LED	TBFV-1/TBFH-1:10~30VAC/DC				TBFV-2/TBFH-2:110~250VAC			

# tend 軌道式端子盤

TBU

## ■ 配 件

材質： PA66尼龍  
工作溫度範圍： -40°C~+100°C

注：包裝數量100.PCS(10PCS 為一條)  
TBU-50N為單PCS(無整條)

### 標示牌

(TBU-2.5N用)	(TBU-4N用)	(TBU-6N用)	(TBU-10N,TB-16N,TB-35N用)	說明	包裝數
型號	型號	型號	型號		
TBU2.5N-A	TBU4N-A	TBU6N-A	TBU10N-A	空白	100
TBU2.5N-A1	TBU4N-A1	TBU6N-A1	TBU10N-A1	1	100
TBU2.5N-A2	TBU4N-A2	TBU6N-A2	TBU10N-A2	2	100
TBU2.5N-A3	TBU4N-A3	TBU6N-A3	TBU10N-A3	3	100
TBU2.5N-A4	TBU4N-A4	TBU6N-A4	TBU10N-A4	4	100
TBU2.5N-A5	TBU4N-A5	TBU6N-A5	TBU10N-A5	5	100
TBU2.5N-A6	TBU4N-A6	TBU6N-A6	TBU10N-A6	6	100
TBU2.5N-A7	TBU4N-A7	TBU6N-A7	TBU10N-A7	7	100
TBU2.5N-A8	TBU4N-A8	TBU6N-A8	TBU10N-A8	8	100
TBU2.5N-A0	TBU4N-A0	TBU6N-A0	TBU10N-A0	0	100
TBU2.5N-A18	TBU4N-A18	TBU6N-A18	TBU10N-A18	18	100
TBU2.5N-A21	TBU4N-A21	TBU6N-A21	TBU10N-A21	21	100
TBU2.5N-A22	TBU4N-A22	TBU6N-A22	TBU10N-A22	22	100
TBU2.5N-A23	TBU4N-A23	TBU6N-A23	TBU10N-A23	23	100
TBU2.5N-A24	TBU4N-A24	TBU6N-A24	TBU10N-A24	24	100
TBU2.5N-A41	TBU4N-A41	TBU6N-A41	TBU10N-A41	41	100
TBU2.5N-A42	TBU4N-A42	TBU6N-A42	TBU10N-A42	42	100
TBU2.5N-AR	TBU4N-AR	TBU6N-AR	TBU10N-AR	R	100
TBU2.5N-AS	TBU4N-AS	TBU6N-AS	TBU10N-AS	S	100
TBU2.5N-AT	TBU4N-AT	TBU6N-AT	TBU10N-AT	T	100
TBU2.5N-AU-1	TBU4N-AU-1	TBU6N-AU-1	TBU10N-AU-1	U	100
TBU2.5N-AV	TBU4N-AV	TBU6N-AV	TBU10N-AV	V	100
TBU2.5N-AW	TBU4N-AW	TBU6N-AW	TBU10N-AW	W	100
TBU2.5N-AG	TBU4N-AG	TBU6N-AG	TBU10N-AG	G	100
TBU2.5N-A0110	TBU4N-A0110	TBU6N-A0110	TBU10N-A0110	1~10	100
TBU2.5N-A1120	TBU4N-A1120	TBU6N-A1120	TBU10N-A1120	11~20	100
TBU2.5N-A2130	TBU4N-A2130	TBU6N-A2130	TBU10N-A2130	21~30	100
TBU2.5N-A3140	TBU4N-A3140	TBU6N-A3140	TBU10N-A3140	31~40	100
TBU2.5N-A4150	TBU4N-A4150	TBU6N-A4150	TBU10N-A4150	41~50	100
TBU2.5N-AL	TBU4N-AL	TBU6N-AL	TBU10N-AL	L1,L2,L3,N,PE	100
TBU2.5N-AU	TBU4N-AU	TBU6N-AU	TBU10N-AU	U,V,W,N ⊥	100

### 標示牌(TBU-50N,70N,95N,150N用)

型號	說明	包裝數
TBU50N-A	空白	50
TBU50N-A1	1	50
TBU50N-A2	2	50
TBU50N-A3	3	50
TBU50N-A4	4	50
TBU50N-A5	5	50
TBU50N-A6	6	50
TBU50N-A7	7	50
TBU50N-A8	8	50
TBU50N-A0	0	50
TBU50N-AL1	L1	50
TBU50N-AL2	L2	50
TBU50N-AL3	L3	50
TBU50N-AN	N	50
TBU50N-APE	PE	50
TBU50N-AU	U	50
TBU50N-AV	V	50
TBU50N-AW	W	50
TBU50N-AE	⊥	50

1	1	1	1	1	1	1	1	1	1
1	2	3	4	5	6	7	8	9	10
L1	L2	L3	N	PE	L1	L2	L3	N	PE
U	V	W	N	⊥	U	V	W	N	⊥



# tend 軌道式端子盤

TBU

## ■ 配件

### TBU N-CU 上連接片

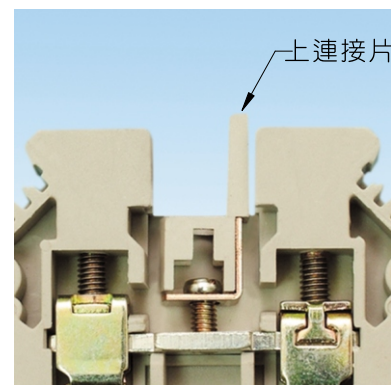
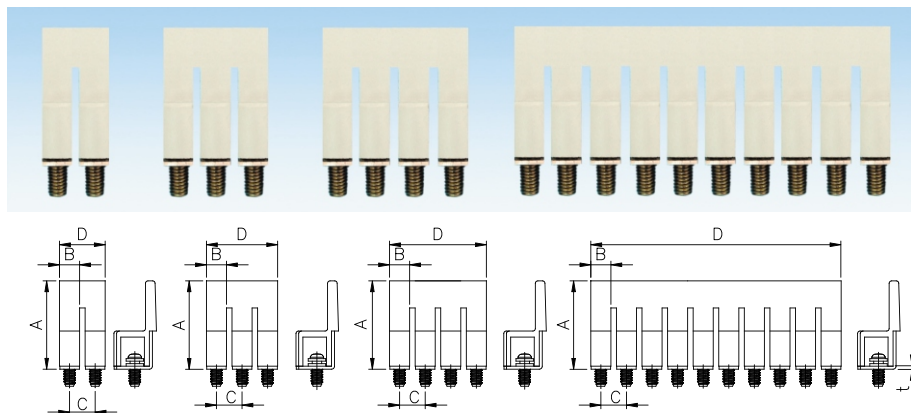

上連接片型號	P數	適用端子盤	包裝數量	尺寸(見上圖)					上連接片型號	P數	適用端子盤	包裝數量	尺寸(見上圖)				
				A	B	C	D	t					A	B	C	D	t
TBU2.5N-CU2	2	TBU-2.5N	50	17.8	4	5.1	9.1	0.6	TBU10N-CU2	2	TBU-10N	50	24.9	8	10.2	18.2	1
TBU2.5N-CU3	3	TBU-2.5N	50	17.8	4	5.1	14.2	0.6	TBU10N-CU3	3	TBU-10N	50	24.9	8	10.2	28.4	1
TBU2.5N-CU4	4	TBU-2.5N	50	17.8	4	5.1	19.3	0.6	TBU10N-CU4	4	TBU-10N	50	24.9	8	10.2	38.6	1
TBU2.5N-CU10	10	TBU-2.5N	20	17.8	4	5.1	49.9	0.6	TBU10N-CU10	10	TBU-10N	20	24.9	8	10.2	99.8	1
TBU4N-CU2	2	TBU-4N	50	18.2	4.5	6.2	10.7	1	TBU16N-CU2	2	TBU-16N	50	26.2	9.4	12	21.4	1
TBU4N-CU3	3	TBU-4N	50	18.2	4.5	6.2	16.9	1	TBU16N-CU3	3	TBU-16N	50	26.2	9.4	12	33.4	1
TBU4N-CU4	4	TBU-4N	50	18.2	4.5	6.2	23.1	1	TBU16N-CU4	4	TBU-16N	50	26.2	9.4	12	45.4	1
TBU4N-CU10	10	TBU-4N	20	18.2	4.5	6.2	60.3	1	TBU16N-CU10	10	TBU-16N	10	26.2	9.4	12	117.4	1
TBU6N-CU2	2	TBU-6N	50	18.2	6.2	8.2	14.4	1	TBU35N-CU2	2	TBU-35N	50	26.8	11.5	15.9	27.4	1.6
TBU6N-CU3	3	TBU-6N	50	18.2	6.2	8.2	22.6	1	TBU35N-CU3	3	TBU-35N	50	26.8	11.5	15.9	43.3	1.6
TBU6N-CU4	4	TBU-6N	50	18.2	6.2	8.2	30.8	1	TBU35N-CU4	4	TBU-35N	50	26.8	11.5	15.9	59.2	1.6
TBU6N-CU10	10	TBU-6N	20	18.2	6.2	8.2	80.0	1	TBU35N-CU10	10	TBU-35N	10	26.8	11.5	15.9	154.6	1.6

### TBU N-CS 側連接片

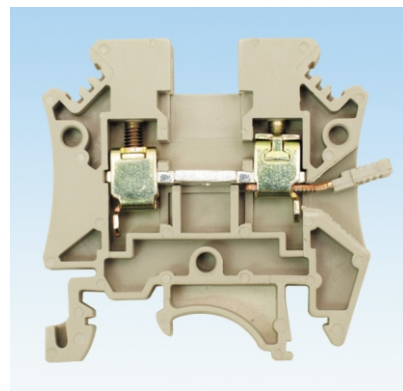
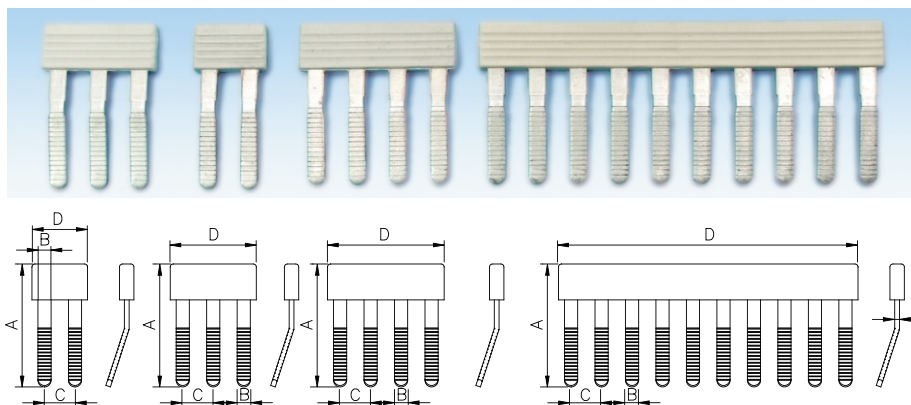

側連接片型號	P數	適用端子盤	包裝數量	尺寸(見上圖)					側連接片型號	P數	適用端子盤	包裝數量	尺寸(見上圖)				
				A	B	C	D	t					A	B	C	D	t
TBU2.5N-CS2	2	TBU-2.5N	50	20.6	2.2	5.1	9.3	0.8	TBU10N-CS2	2	TBU-10N	50	29.4	5.4	10.2	18.4	1.6
TBU2.5N-CS3	3	TBU-2.5N	50	20.6	2.2	5.1	14.4	0.8	TBU10N-CS3	3	TBU-10N	50	29.4	5.4	10.2	28.6	1.6
TBU2.5N-CS4	4	TBU-2.5N	50	20.6	2.2	5.1	19.5	0.8	TBU10N-CS4	4	TBU-10N	50	29.4	5.4	10.2	38.8	1.6
TBU2.5N-CS10	10	TBU-2.5N	20	20.6	2.2	5.1	50.1	0.8	TBU10N-CS10	10	TBU-10N	20	29.4	5.4	10.2	100	1.6
TBU4N-CS2	2	TBU-4N	50	21.5	2.5	6.2	10.7	1	TBU16N-CS2	2	TBU-16N	50	31	6.6	12	21	1.6
TBU4N-CS3	3	TBU-4N	50	21.5	2.5	6.2	16.9	1	TBU16N-CS3	3	TBU-16N	50	31	6.6	12	33	1.6
TBU4N-CS4	4	TBU-4N	50	21.5	2.5	6.2	23.1	1	TBU16N-CS4	4	TBU-16N	50	31	6.6	12	45	1.6
TBU4N-CS10	10	TBU-4N	20	21.5	2.5	6.2	60.3	1	TBU16N-CS10	10	TBU-16N	10	31	6.6	12	117	1.6
TBU6N-CS2	2	TBU-6N	50	23.8	3.6	8.2	14.8	1.2	TBU35N-CS2	2	TBU-35N	50	37.2	8.4	15.9	29.6	1.6
TBU6N-CS3	3	TBU-6N	50	23.8	3.6	8.2	23	1.2	TBU35N-CS3	3	TBU-35N	50	37.2	8.4	15.9	45.6	1.6
TBU6N-CS4	4	TBU-6N	50	23.8	3.6	8.2	31.2	1.2	TBU35N-CS4	4	TBU-35N	50	37.2	8.4	15.9	61.6	1.6
TBU6N-CS10	10	TBU-6N	20	23.8	3.6	8.2	80.4	1.2	TBU35N-CS10	10	TBU-35N	10	37.2	8.4	15.9	157.6	1.6

# tend 軌道式端子盤

TBU

## ■ 配件

TBU2.5N-H

TBU-2.5N側蓋 (適用於TBU-2.5N~16N)

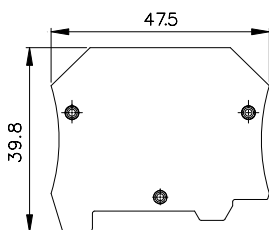

TBU35N-H

TBU-35N側蓋 (適用於TBU-35N)

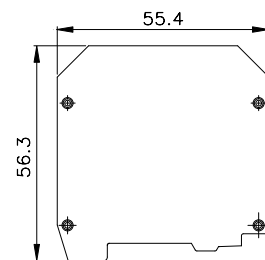

TBU2.5N-F

TBU-2.5N擋片 (適用於2.5N~16N)

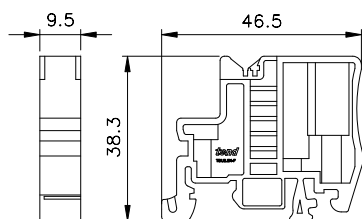
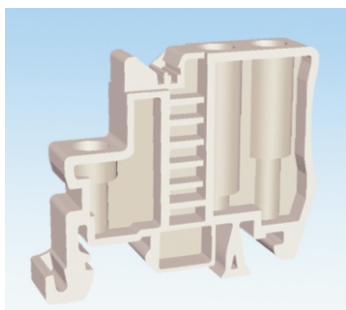

TBU35N-F

TBU-35N擋片 (適用於35N~150N)

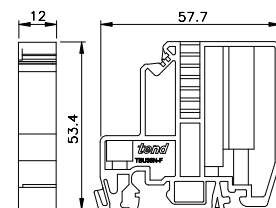
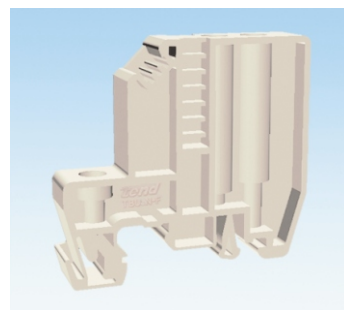

TBU2.5N-K

TBU-2.5N分隔片 (適用於TBU-2.5N~16N)

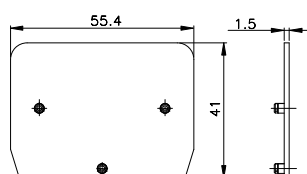

TBU2.5N-B

TBU-2.5N擋片標示牌

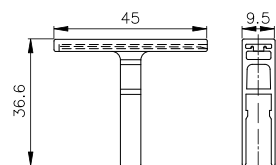

TBR-N 鋁軌

TBR-S 鋼軌

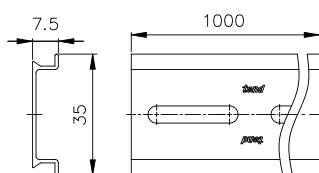

TBU2.5N-T

TBU-2.5N 標記牌

