

tend TN2 Ø22/Ø25/Ø30系列控制器材

TN2

●本系列控制器材,上部與接點座部份可分離,除二點式按鈕、及二點式照光按鈕外(IP40),全系列保護構造皆為IP65(IEC144),可防水、防油、防塵、適用於較惡劣之環境。

●本系列控制器材UL認證產品外觀全為灰色,無UL認證上部為灰色,下部為黑色。

■ 按鈕開關組立圖

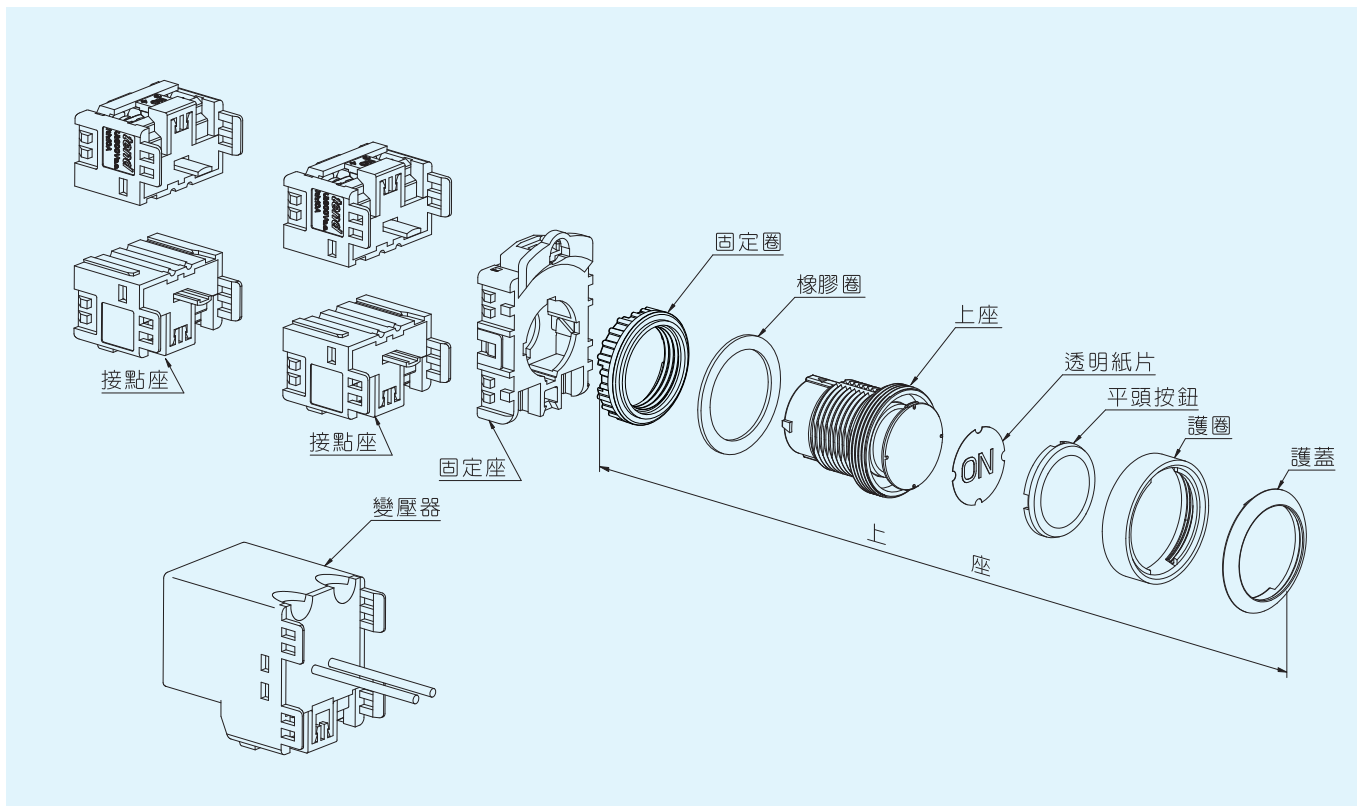

■ 特性

本系列開關為三段可拆組式開關,分為上座、固定座、接點座三部份。

● 上座與固定座之裝卸(如圖一)

● 固定座與接點座之裝卸(如圖二)

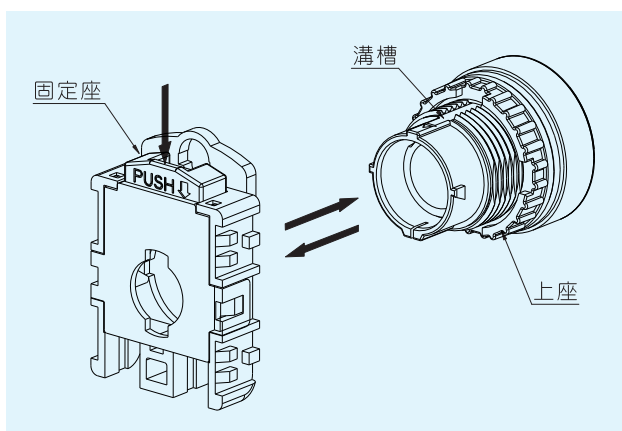

(圖一)

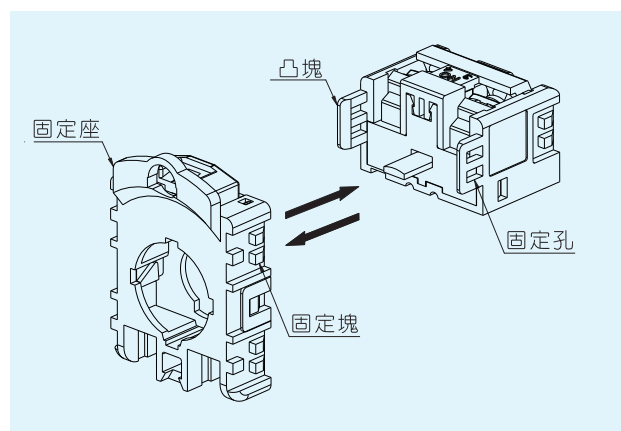

(圖二)

裝配：固定座橙色滑塊之 **PUSH** ↓對準上座螺牙溝槽壓入,即可固定。

裝配：固定座上凸出之固定塊對準接點座之固定孔推入,即可固定。

拆卸：以手或以起子(螺絲刀)插入橙色滑塊上端之圓孔內,下壓橙色滑塊即可拆卸。

拆卸：以一字起子(螺絲刀),分別插入接點座之凸塊往上撬起,即可拆卸。

tend TN2 Ø22/Ø25/Ø30系列控制器材

TN2

■ 裝配孔徑與距離

Ø22/Ø25/Ø30系列

尺寸說明：所有尺寸均為mm

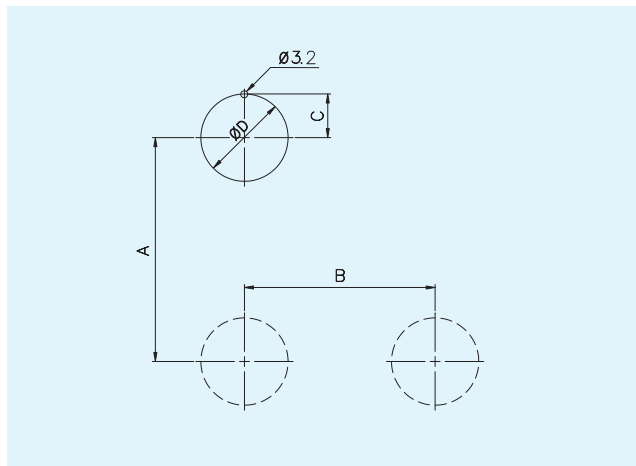

系	列	Ø22	Ø25	Ø30
A	二點式按鈕及十字開關以外所有機種	50min.		
	二點式按鈕	60min.		
	十字開關	90min.		
B	指示燈·按鈕·選擇·附銘板	31	31	35
	大頭·連鎖·長柄選擇·二點式按鈕	41min.		
		39min.		
	十字開關	90min.		
C	所有機種	11.2	12.7	15.2
D	所有機種	22.4	25.4	30.4

■ 上部之裝配

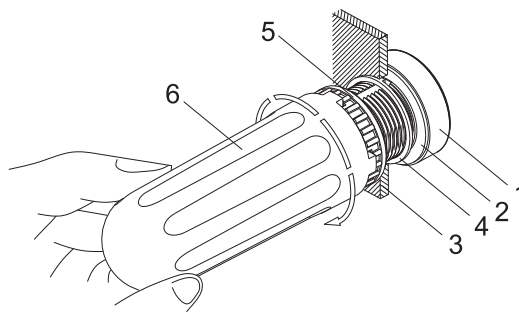
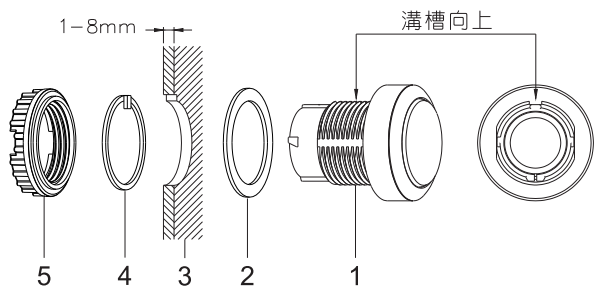

1	2	3	4	5	6
上座	橡膠圈	面板	止動環	固定圈	固定器

●上座與橡膠圈置於盤面，插入孔徑，止動環置於盤內對準上座與固定盤面之溝槽迫緊，再將固定圈鎖緊即可。

■ 文字與符號之標示

透明印刷紙片（種類見PTA92）

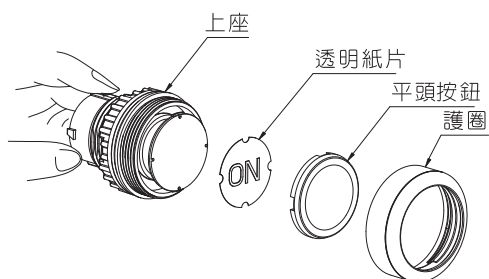

■ 燈泡替換方法

以T2-A燈泡拆卸器（見TA67）插入燈泡，順時針方向旋轉可將燈泡固定，反時針方向旋轉可將燈泡取下。

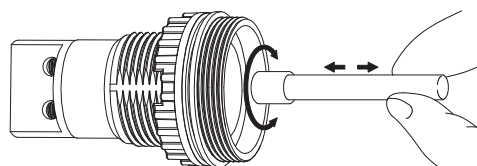

■ Ø22mm/Ø25mm系列尺寸與構造完全相同，● Ø30系列裝配方法由一共用之固定圈固定之。

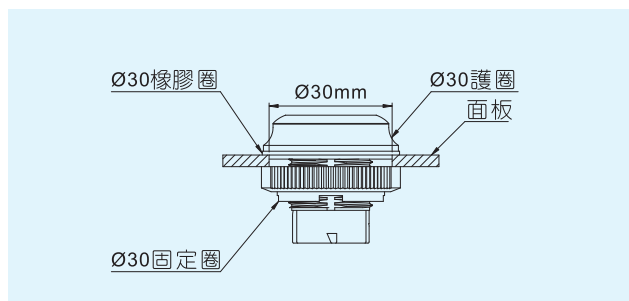
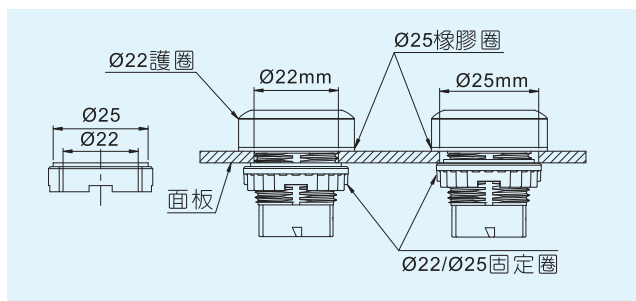

tend TN2 Ø22/Ø25/Ø30系列控制器材

TN2

■ 固定座的種類

固定座依其組裝及功能上的不同，共有以下三種。

標準固定座 (TN2-1)



直接式固定座 (TN2-2)



變壓器固定座 (TN2-3)



■ 接點座種類與加裝

接點座可分1a(1NO)、1b(1NC)、1c(1NO、1NC)三種，可自由加裝。

TN2-A(1a)

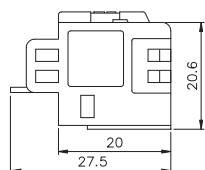

TN2-B(1b)

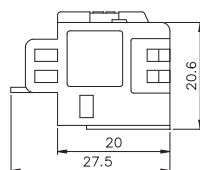

TN2-C(1c)

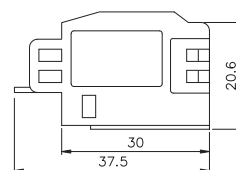

■ 接點座依其加裝在不同的成品系列，有三種型式。

1. 接點座加裝在標準固定座之後，稱為標準接點座，最多可裝至4C(或8a或8b)，用於不帶燈的系列。
2. 接點座加裝在直接式固定座之後，稱為直接式接點座，最多可裝至4C(或8a或8b)，用於所有帶燈的開關。
3. 接點座加裝在變壓器固定座之後，稱為變壓器接點座，最多可裝至2C(或4a或4b)，用於變壓器照光式系列。

■ 標準接點座外觀尺寸

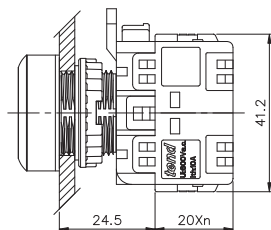
TN2-1a~TN2-8a
TN2-1b~TN2-8b

n=p數

■ 直接式接點座外觀尺寸

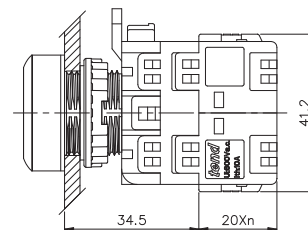
TN2-I1a~TN2-I8a
TN2-I1b~TN2-I8b

n=p數

TN2-1c~TN2-4c

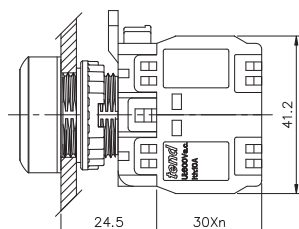

n=p數

TN2-I1c~TN2-I4c

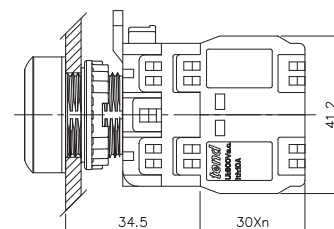

n=p數

tend TN2 Ø22/Ø25/Ø30系列控制器材

TN2

變壓器接點座外觀尺寸

TN2-T1a~TN2-T4a.TN2-T1ab
TN2-T1b~TN2-T4b

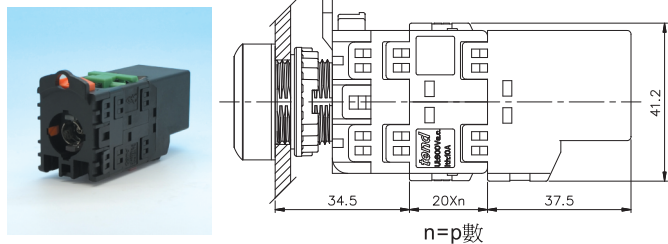

TN2-T2c

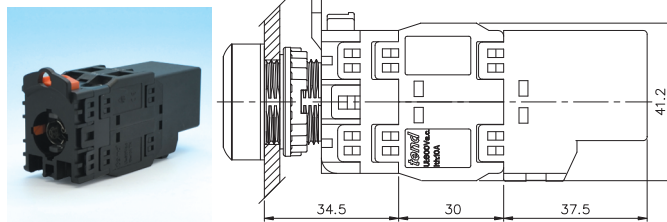

接點額定值

交流	AC11	AC24V	AC110V	AC220V	AC380V	AC440V	直 流	DC11	DC24V	DC110V	DC220V	DC380V
	電感負載	10A	6A	4A	2.5A	2A		電感負載	1.5A	0.5A	0.2A	0.1A
	電阻負載	10A	10A	6A	5A	4A		DC14 電阻負載	10A	2A	0.6A	0.2A

特性

動作頻率	機 械	復歸式按鈕為60次/分,其餘為30次/分
	電 氣	30次/分
壽 命	機 械	復歸式按鈕為3,000,000次,其餘為300,000次
	電 氣	復歸式按鈕為500,000次,其餘為200,000次
衝 擊	耐 久	變壓器系列為600m/s ² ,其餘為1000m/s ²
	誤動作	非照光式復歸按鈕為1000m/s ² ,其餘為250m/s ²
振 動	誤動作	10~55Hz複振幅1.5mm
接觸電阻	50mΩ以下(初期值)	
絕緣電阻	500VDC電壓下,100MΩ以上	
耐電壓	接受AC2500V之測試電壓一分種,無短路,破壞,燒毀等異常現象	
周圍溫度	-20°C~+60°C	
周圍濕度	45~85%RH	

標準接點座接點圖

型 式	TN2-1A	TN2-1B	TN2-1C	TN2-2A	TN2-2B	TN2-2C
接 點	1a	1b	1a1b	2a	2b	2a2b
接 點 圖						

型 式	TN2-3A	TN2-3B	TN2-3C	TN2-4A	TN2-4B	TN2-4C
接 點	3a	3b	3a3b	4a	4b	4a4b
接 點 圖						

tend TN2 Ø22/Ø25/Ø30按鈕開關

TN2

本系列開關接點座為標準接點座，其接點形式、接點圖、裝配尺寸見TA75,76頁。二點式接點限用AB。

型號說明

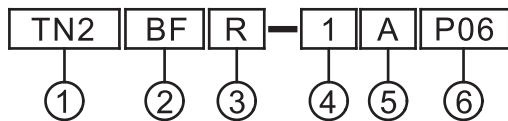

註：1. 第6項選00時為無刻字。

2. 如有選第6項時，鈕的顏色皆為清澈透明，紅、黃、綠等顏色在護蓋上顯示。（僅限平頭及凸頭）

如下圖：

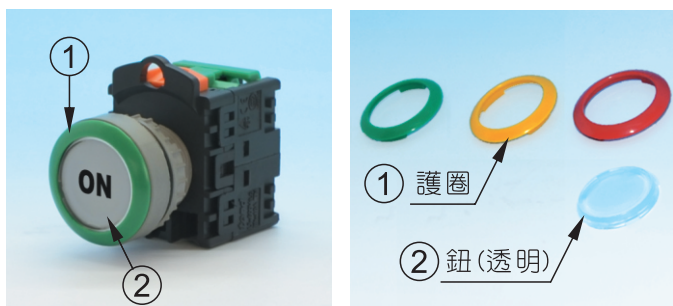

項次	代號	說明
1. 固定孔徑	TN2 TN3	Ø22mm/Ø25mm Ø30mm
2. 型式	BF BL BM BA BK BP BT	平頭 凸頭 大頭 凸頭交替式 連鎖式 按拉式 二點式(接點限用AB)
3. 顏色	R G Y W BL B	紅 綠 黃 白 藍(限第6項有選) 黑
4. 接點數目	1 2 3 4	1組 2組 3組 4組
5. 接點種類	A B C AB	1a 1b 1a1b 1a+1b
6. 刻字種類	00 P01~P43 M01~M22	無刻字 詳見 TA92 TPP 詳見 TA92 TPM

按鈕上座部份裝配尺寸

TN2BF

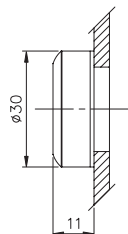

TN3BF

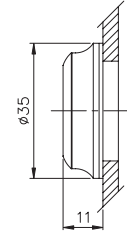

TN2BL

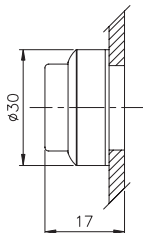

TN3BL

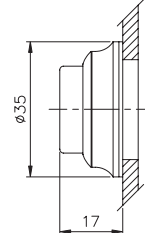

TN2BM

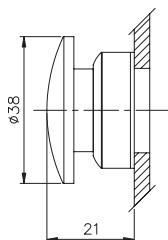

TN3BM

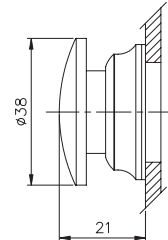

TN2BA

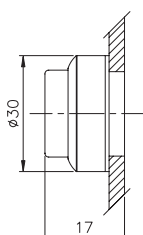

TN3BA

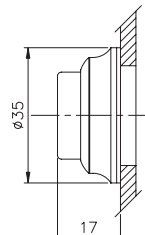

tend TN2 Ø22/Ø25/Ø30按鈕開關

TN2

TN2BK

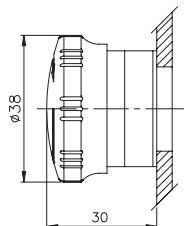
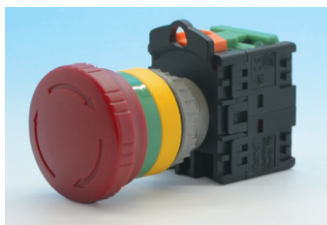

TN3BK

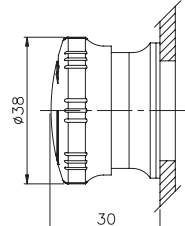

TN2BP

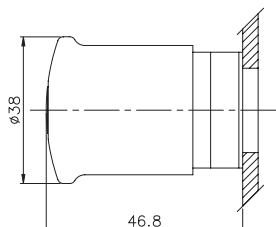
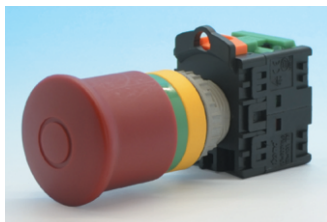

TN3BP

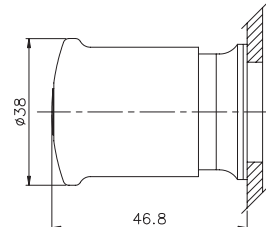
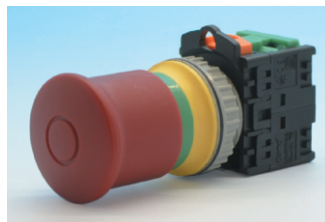

TN2BT

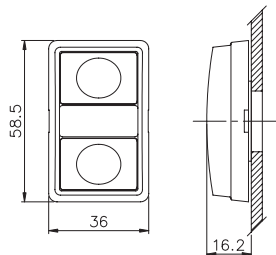

TN3BT

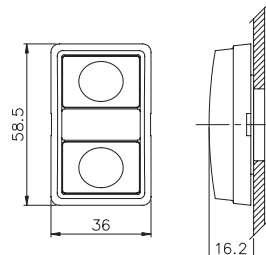
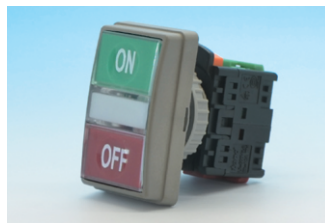

型號說明

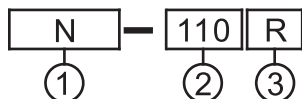

項次	代號	說明
1. 燈泡種類	I	鎢絲燈泡(無顏色)
	N	霓虹燈泡
	L	LED燈泡
2. 電壓	6	6V AC/DC
	12	12V AC/DC
	18	18V AC/DC
	24	24V AC/DC
	30	30V AC/DC
	110	110V AC
	220	220V AC
	380	380V AC
440	440V AC	
3. 顏色	R	紅
	G	綠
	O	橙
	W BL	白 藍

燈泡規格 (含照光式與指示燈)

燈泡種類	額定電壓	額定電流
鎢絲燈泡	6V AC/DC	150mA
	12V AC/DC	100mA
	18V AC/DC	66mA
	24V AC/DC	50mA
	30V AC/DC	40mA
霓虹燈泡	110V AC	1.3mA
	220V AC	2.2mA
	380V AC	1.15mA
LED燈泡	440V AC	1.4mA
	6V AC/DC	9~13mA
	12V AC/DC	9~13mA
	24V AC/DC	8~13mA
	30V AC/DC	8~13mA
	110V AC	3~5mA
	220V AC	3~5mA

燈泡全部為BA9S-11X28mm(Ø9)，最大功率1.2W

燈泡外觀尺寸

● 鎢絲燈泡

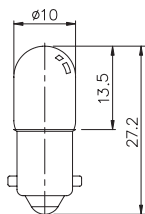

● 霓虹燈泡

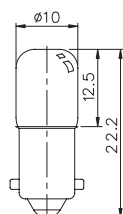

● LED燈泡

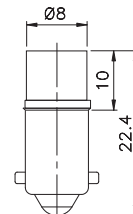

tend TN2 Ø22/Ø25/Ø30直接式照光按鈕開關

TN2

本系列開關接點座為直接式接點座，燈泡種類與規格，見TA78頁。二點式接點限用AB。

型號說明

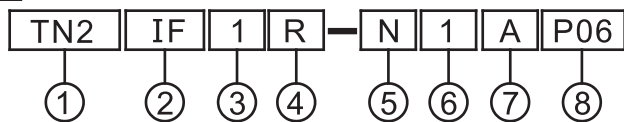

項次	代號	說明
1. 固定孔徑	TN2 TN3	Ø22mm/Ø25mm Ø30mm
2. 型式	IF IL IM IA IK IT IC	平頭 凸頭 大頭 凸頭交替式 連鎖式 二點式(接點限用AB) 全罩式凸頭

項次	代號	說明
3. 電壓	1	110VAC (霓虹、LED燈泡)
	2	220VAC (霓虹、LED燈泡)
	3	380VAC (霓虹燈泡)
	4	440VAC (霓虹燈泡)
	5	6VAC/DC (鎢絲、LED燈泡)
	6	18VAC/DC (鎢絲燈泡)
	7	24VAC/DC (鎢絲、LED燈泡)
	8	30VAC/DC (鎢絲、LED燈泡)
	9	12VAC/DC (鎢絲、LED燈泡)
4. 顏色	R	紅
	G	綠
	O	橙
	W	白
	BL	藍
	C	透明 (限第8項有選)
5. 燈泡種類	I	鎢絲燈泡
	N L	霓虹燈泡 LED燈泡
6. 接點數目	1	1組
	2	2組
	3	3組
	4	4組
7. 接點種類	A	1a
	B	1b
	C	1a1b
	AB	1a+1b
8. 刻字種類	00	無刻字
	P01~P43 M01~M22	詳見 TA92 TPP 詳見 TA92 TPM

註：1. 第8項選00時為無刻字。

2. 如有選第8項時，鈕的顏色皆為清澈透明，紅、

黃、綠等顏色在護蓋上顯示。(僅限平頭及凸頭)

如下圖：

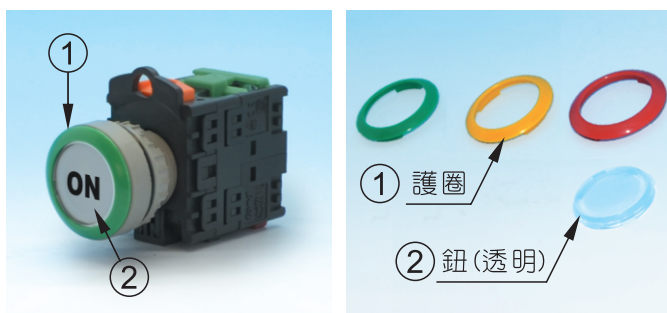

直接式照光按鈕上座裝配尺寸

TN2IF

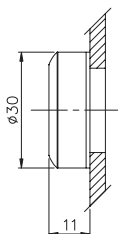

TN3IF

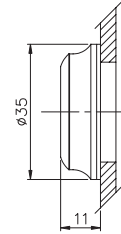

TN2IL

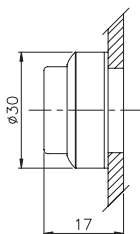

TN3IL

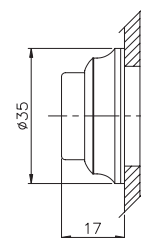

TN2IM

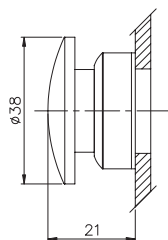
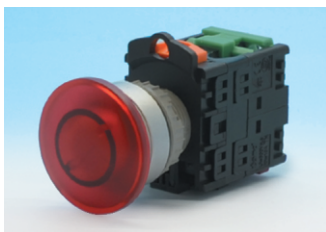

TN3IM

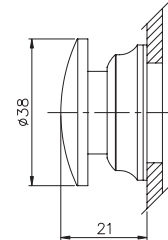

tend TN2 Ø22/Ø25/Ø30 直接式照光按鈕開關

TN2

TN2IA

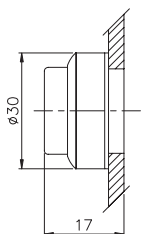

TN3IA

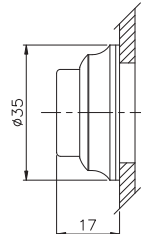

TN2IK

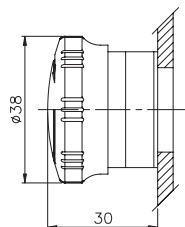

TN3IK

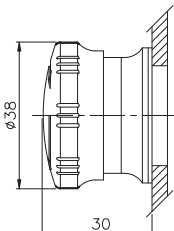
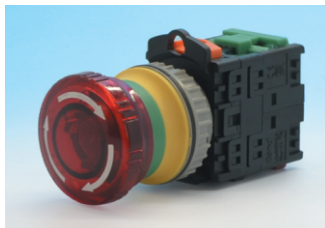

TN2IT

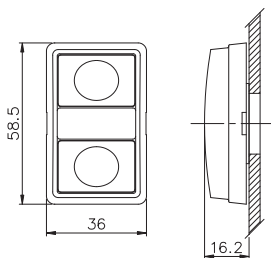

TN3IT

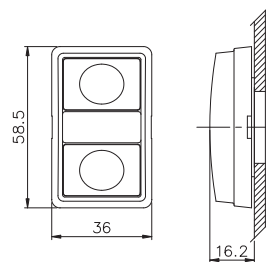

TN2IC

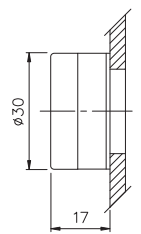

TN3IC

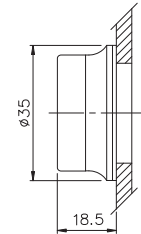

直接式照光接點座接點圖

型 式	TN2-I1A	TN2-I1B	TN2-I1C	TN2-I2A	TN2-I2B	TN2-I2C
接 點	1a	1b	1a1b	2a	2b	2a2b
接 點 圖						
型 式	TN2-I3A	TN2-I3B	TN2-I3C	TN2-I4A	TN2-I4B	TN2-I4C
接 點	3a	3b	3a3b	4a	4b	4a4b
接 點 圖						

tend TN2 Ø22/Ø25/Ø30照光式按鈕開關

TN2

本系列開關為附變壓器式，二次電壓全部為5V，一律使用鎢絲（6V）燈泡，見TA78頁，接點座採用變壓器接點座，裝配尺寸見TA76頁。接點種類不可選用1C。二點式接點限用AB。

型號說明

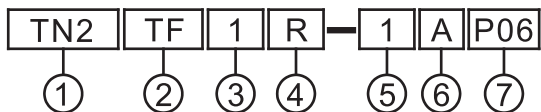

項次	代號	說明
1. 固定孔徑	TN2 TN3	Ø22mm/Ø25mm Ø30mm

註：1. 第7項選00時為無刻字。
2. 如有選第7項時，鈕的顏色皆為清澈透明，紅、黃、綠等顏色在護蓋上顯示。（僅限平頭及凸頭）

如下圖：

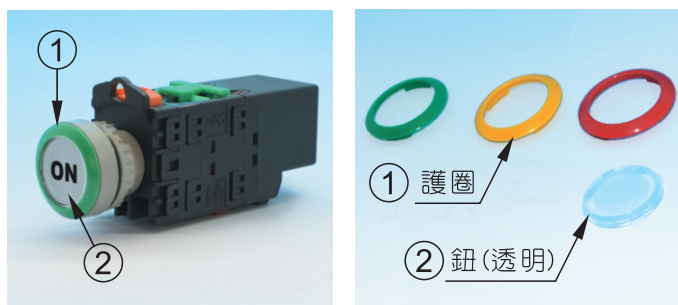

項次	代號	說明
2. 型式	TF	平頭
	TL	凸頭
	TM	大頭
	TA	凸頭交替式
	TK	連鎖式
	TT	二點式(接點限用AB)
	TC	全罩式凸頭
3. 電壓	1	110VAC
	2	220VAC
	3	380VAC
	4	440VAC
4. 顏色	R	紅
	G	綠
	O	橙
	W BL	黑 藍
5. 接點數目	1	1組
	2	2組
6. 接點種類	A	1a
	B	1b
	C	1a1b (僅限2C, 1C不可裝配)
	AB	1a+1b
7. 刻字種類	00	無刻字
	P01~P43	詳見 TA92 TPP
	M01~M22	詳見 TA92 TPM

照光式按鈕上座裝配尺寸

TN2TF

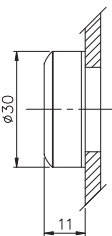

TN3TF

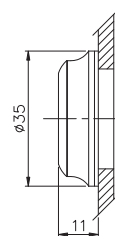

TN2TL

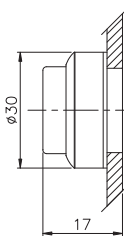

TN3TL

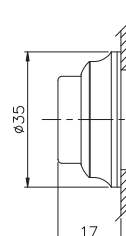

TN2TM

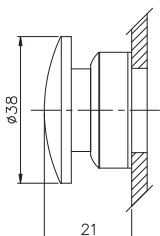

TN3TM

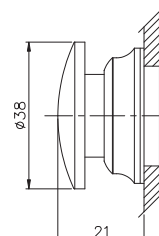

TN2TA

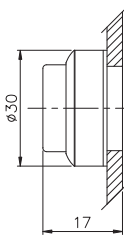

TN3TA

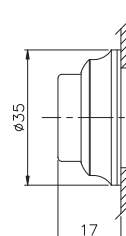

tend TN2 Ø22/Ø25/Ø30照光式按鈕開關

TN2

TN2TK

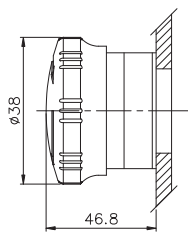
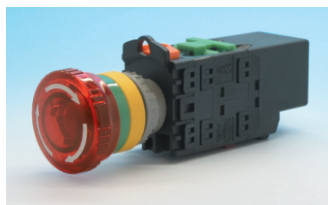

TN3TK

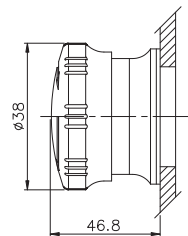
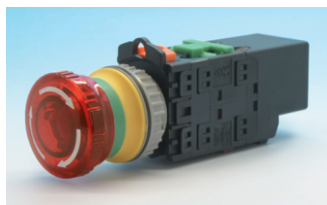

TN2TT

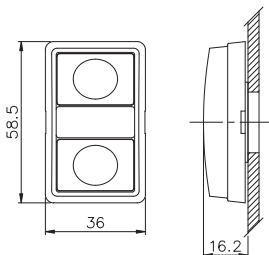

TN3TT

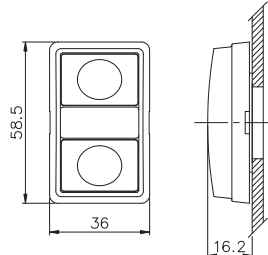
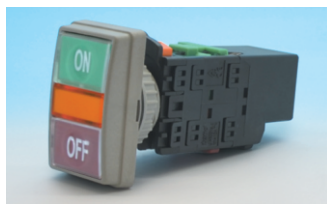

TN2TC

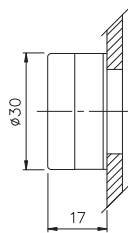

TN3TC

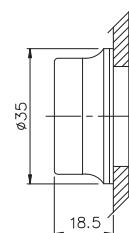
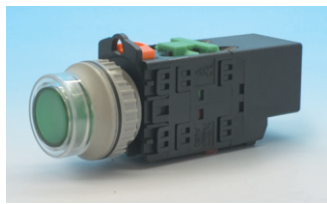

照光式接點座附變壓器接點圖

型式	TN2-T1A	TN2-T1B	TN2-T1AB	TN2-T2A	TN2-T2B	TN2-T2C
接點	1a	1b	1a+1b	2a	2b	2a2b
接點圖						

tend TN2 Ø22/Ø25/Ø30選擇開關、鑰匙開關

TN2

本系列開關之接點座採用標準接點座, 裝配尺寸見TA75頁, 二段式接點1C為1a1b, 三段式接點AA為1a+1a(2a)。

型號說明

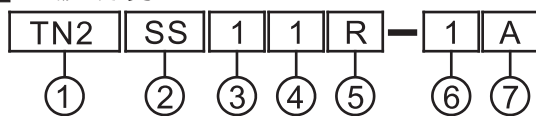

項次	代號	說明
1. 固定孔徑	TN2 TN3	Ø22mm/Ø25mm Ø30mm
2. 型式	SS SH KS	標準選擇 長柄選擇 鑰匙選擇
3. 動作方式	1	三段90°X2
	2	二段90°
	3	二段90°復歸
	4	三段45°X2
	5	三段45°X2右邊復歸
	6	三段45°X2左邊復歸
	7	三段45°X2雙復歸

項次	代號	說明	
4. 鑰匙抽出位置	1	二段 0、1皆可抽出 0可抽出 1可抽出	
	2		
	3		
	5. 顏色	4	三段 0、1、2皆可抽出 0可抽出 0、1、2皆可抽出 0可抽出
		5	
		6	
		7	
6. 接點數目	R	紅 綠 黑	
	G		
	B		
	—		
7. 接點種類	1	二段 三段	
	2		
	3		
	4		
7. 接點種類	A	1a	—
	B	1b	—
	C	1a1b	—
	AB	1a+1b	—
	AA	—	1a + 1a(2a)

三段接點座限選用AA

tend TN2 Ø22/Ø25/Ø30 選擇開關、鑰匙開關

TN2

■ 選擇、鑰匙上座部份裝配尺寸

TN2SS

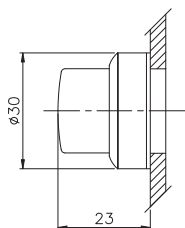

TN3SS

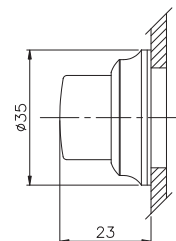

TN2SH

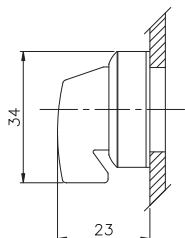

TN3SH

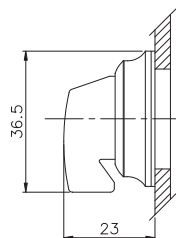

TN2KS

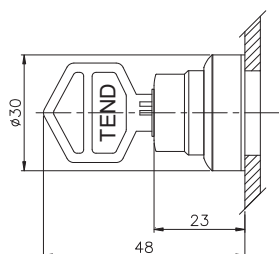

TN3KS

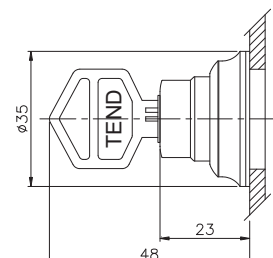

■ 選擇開關二段接點圖

型 式	TN2-1A	TN2-1B	TN2-1C	TN2-2A	TN2-2B	TN2-2C																																													
接 點	1a	1b	1a1b	2a	2b	2a2b																																													
接 點 圖																																																			
	<table border="1"> <tr><td>接點</td><td>0</td><td>1</td></tr> <tr><td>3-4</td><td></td><td>X</td></tr> </table>	接點	0	1	3-4		X	<table border="1"> <tr><td>接點</td><td>0</td><td>1</td></tr> <tr><td>1-2</td><td>X</td><td></td></tr> </table>	接點	0	1	1-2	X		<table border="1"> <tr><td>接點</td><td>0</td><td>1</td></tr> <tr><td>1-2</td><td>X</td><td></td></tr> <tr><td>3-4</td><td></td><td>X</td></tr> </table>	接點	0	1	1-2	X		3-4		X	<table border="1"> <tr><td>接點</td><td>0</td><td>1</td></tr> <tr><td>3-4</td><td></td><td>X</td></tr> </table>	接點	0	1	3-4		X	<table border="1"> <tr><td>接點</td><td>0</td><td>1</td></tr> <tr><td>1-2</td><td>X</td><td></td></tr> <tr><td>3-4</td><td></td><td>X</td></tr> </table>	接點	0	1	1-2	X		3-4		X	<table border="1"> <tr><td>接點</td><td>0</td><td>1</td></tr> <tr><td>1-2</td><td>X</td><td></td></tr> <tr><td>3-4</td><td></td><td>X</td></tr> </table>	接點	0	1	1-2	X		3-4		X
接點	0	1																																																	
3-4		X																																																	
接點	0	1																																																	
1-2	X																																																		
接點	0	1																																																	
1-2	X																																																		
3-4		X																																																	
接點	0	1																																																	
3-4		X																																																	
接點	0	1																																																	
1-2	X																																																		
3-4		X																																																	
接點	0	1																																																	
1-2	X																																																		
3-4		X																																																	

■ 選擇開關三段接點圖

型 式	TN2-1AA	TN2-2AA																																
接 點	1a 0 1a	2a 0 2a																																
接 點 圖	<table border="1"> <tr><td>接點</td><td>1</td><td>0</td><td>2</td></tr> <tr><td>3-4</td><td>X</td><td></td><td></td></tr> <tr><td>3-4</td><td></td><td></td><td>X</td></tr> </table>	接點	1	0	2	3-4	X			3-4			X	<table border="1"> <tr><td>接點</td><td>1</td><td>0</td><td>2</td></tr> <tr><td>3-4</td><td>X</td><td></td><td></td></tr> <tr><td>3-4</td><td>X</td><td></td><td></td></tr> <tr><td>3-4</td><td></td><td></td><td>X</td></tr> <tr><td>3-4</td><td></td><td></td><td>X</td></tr> </table>	接點	1	0	2	3-4	X			3-4	X			3-4			X	3-4			X
接點	1	0	2																															
3-4	X																																	
3-4			X																															
接點	1	0	2																															
3-4	X																																	
3-4	X																																	
3-4			X																															
3-4			X																															

tend TN2 Ø22/Ø25/Ø30直接式照光選擇開關

TN2

本系列開關之接點座採用直接式接點座，裝配尺寸見TA75頁，燈泡種類與規格同直接式照光按鈕開關，見TA78頁。兩段式接點1c為1a1b，三段式接點AA為1a+1b(2a)。

型號說明

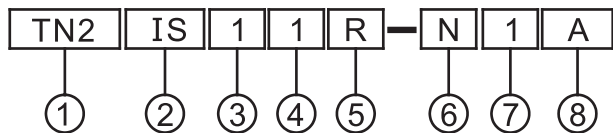

項次	代號	說明
1. 固定孔徑	TN2 TN3	Ø22mm/Ø25mm Ø30mm
2. 型式	IS IH	標準選擇 長柄選擇
3. 動作方式	1	三段90°X2
	2	二段90°
	3	二段90°復歸
	4	三段45°X2
	5	三段45°X2右邊復歸
	6	三段45°X2左邊復歸
	7	三段45°X2二邊復歸

項次	代號	說明	
4. 電壓	1	110VAC (霓虹、LED燈泡)	
	2	220VAC (霓虹、LED燈泡)	
	3	380VAC (霓虹燈泡)	
	4	440VAC (霓虹燈泡)	
	5	6VAC/DC (鎢絲、LED燈泡)	
	6	18VAC/DC (鎢絲燈泡)	
	7	24VAC/DC (鎢絲、LED燈泡)	
	8	30VAC/DC (鎢絲、LED燈泡)	
	9	12VAC/DC (鎢絲、LED燈泡)	
5. 顏色	R	紅	
	G	綠	
	O	橙	
	W	白	
	BL	藍	
6. 燈泡種類	I	鎢絲燈泡	
	N	霓虹燈泡	
	L	LED燈泡	
7. 接點數目	1	1組	
	2	2組	
	3	3組	
	4	4組	
8. 接點種類	A B C AB AA	二段	三段
		1a 1b 1a1b 1a+1b —	— — — — 1a + 1a(2a)

三段接點座限選用AA

直接式照光選擇上座部份裝配尺寸

TN2IS

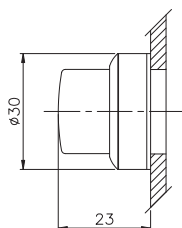

TN3IS

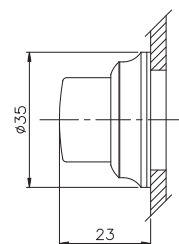

TN2IH

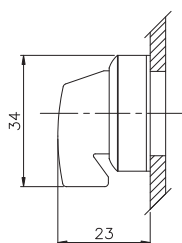
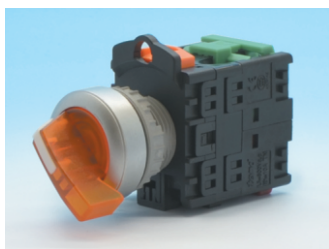

TN3IH

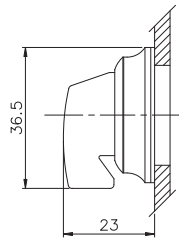

tend TN2 Ø22/Ø25/Ø30直接式照光選擇開關

TN2

直接式照光選擇開關二段接點圖

型 式	TN2-I1A	TN2-I1B	TN2-I1C	TN2-I2A	TN2-I2B	TN2-I2C																																													
接 點	1a	1b	1a1b	2a	2b	2a2b																																													
接 點 圖																																																			
	<table border="1"> <tr><td>接點</td><td>0</td><td>1</td></tr> <tr><td>3-4</td><td></td><td>X</td></tr> </table>	接點	0	1	3-4		X	<table border="1"> <tr><td>接點</td><td>0</td><td>1</td></tr> <tr><td>1-2</td><td>X</td><td></td></tr> </table>	接點	0	1	1-2	X		<table border="1"> <tr><td>接點</td><td>0</td><td>1</td></tr> <tr><td>1-2</td><td>X</td><td></td></tr> <tr><td>3-4</td><td></td><td>X</td></tr> </table>	接點	0	1	1-2	X		3-4		X	<table border="1"> <tr><td>接點</td><td>0</td><td>1</td></tr> <tr><td>3-4</td><td></td><td>X</td></tr> </table>	接點	0	1	3-4		X	<table border="1"> <tr><td>接點</td><td>0</td><td>1</td></tr> <tr><td>1-2</td><td>X</td><td></td></tr> <tr><td>3-4</td><td></td><td>X</td></tr> </table>	接點	0	1	1-2	X		3-4		X	<table border="1"> <tr><td>接點</td><td>0</td><td>1</td></tr> <tr><td>1-2</td><td>X</td><td></td></tr> <tr><td>3-4</td><td></td><td>X</td></tr> </table>	接點	0	1	1-2	X		3-4		X
接點	0	1																																																	
3-4		X																																																	
接點	0	1																																																	
1-2	X																																																		
接點	0	1																																																	
1-2	X																																																		
3-4		X																																																	
接點	0	1																																																	
3-4		X																																																	
接點	0	1																																																	
1-2	X																																																		
3-4		X																																																	
接點	0	1																																																	
1-2	X																																																		
3-4		X																																																	

直接式照光選擇開關三段接點圖

型 式	TN2-I1AA	TN2-I2AA																																
接 點	1a 0 1a	2a 0 2a																																
接 點 圖	<table border="1"> <tr><td>接點</td><td>1</td><td>0</td><td>2</td></tr> <tr><td>3-4</td><td>X</td><td></td><td></td></tr> <tr><td>3-4</td><td></td><td></td><td>X</td></tr> </table>	接點	1	0	2	3-4	X			3-4			X	<table border="1"> <tr><td>接點</td><td>1</td><td>0</td><td>2</td></tr> <tr><td>3-4</td><td>X</td><td></td><td></td></tr> <tr><td>3-4</td><td>X</td><td></td><td></td></tr> <tr><td>3-4</td><td></td><td></td><td>X</td></tr> <tr><td>3-4</td><td></td><td></td><td>X</td></tr> </table>	接點	1	0	2	3-4	X			3-4	X			3-4			X	3-4			X
接點	1	0	2																															
3-4	X																																	
3-4			X																															
接點	1	0	2																															
3-4	X																																	
3-4	X																																	
3-4			X																															
3-4			X																															

tend TN2 Ø22/Ø25/Ø30照光式選擇開關

TN2

本系列開關為附變壓器式，二次電壓全部為5V，一律使用鎢絲(6V)燈泡，見TA78頁，接點座用變壓器接點座，裝配尺寸見TA76頁。三段式接點種類AA為1a+1a(2a)。

型號說明

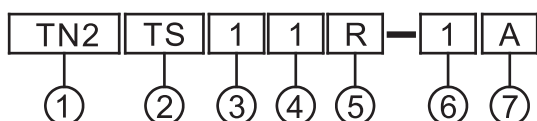

項 次	代 號	說 明
1. 固定孔徑	TN2 TN3	Ø22mm/Ø25mm Ø30mm
2. 型 式	TS TH	標準選擇 長柄選擇
3. 動作方式	1	三段90°X2
	2	二段90°
	3	二段90°復歸
	4	三段45°X2
	5	三段45°X2右邊復歸
	6	三段45°X2左邊復歸
	7	三段45°X2二邊復歸

項 次	代 號	說 明	
4. 電 壓	1	110VAC	
	2	220VAC	
	3	380VAC	
	4	440VAC	
5. 顏 色	R	紅	
	G	綠	
	O	橙	
	W	白	
7. 接點數目	1	1組	
	2	2組	
8. 接點種類		二段	三段
	A	1a	—
	B	1b	—
	C	1a1b	—
	AB	1a+1b	—
	AA	—	1a + 1a(2a)

三段接點座限選用AA

tend TN2 Ø22/Ø25/Ø30照光式選擇開關

TN2

照光式選擇開關上座部份裝配尺寸

TN2TS

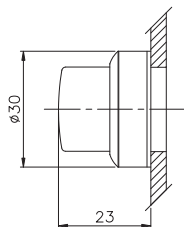

TN3TS

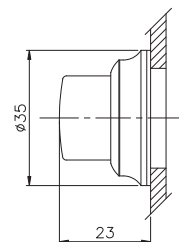

TN2TH

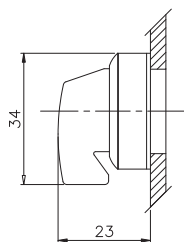

TN3TH

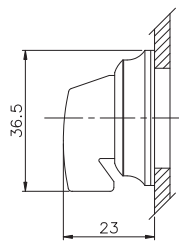

照光式選擇開關二段接點圖

型 式	TN2-T1A	TN2-T1B	TN2-T1AB	TN2-T2A	TN2-T2B	TN2-T2C																																																						
接 點	1a	1b	1a+1b	2a	2b	2a2b																																																						
接 點 圖																																																												
	<table border="1"> <tr><td>接點</td><td>0</td><td>1</td></tr> <tr><td>3-4</td><td></td><td>X</td></tr> </table>	接點	0	1	3-4		X	<table border="1"> <tr><td>接點</td><td>0</td><td>1</td></tr> <tr><td>1-2</td><td>X</td><td></td></tr> </table>	接點	0	1	1-2	X		<table border="1"> <tr><td>接點</td><td>1</td><td>1</td></tr> <tr><td>1-2</td><td>X</td><td></td></tr> <tr><td>3-4</td><td></td><td>X</td></tr> </table>	接點	1	1	1-2	X		3-4		X	<table border="1"> <tr><td>接點</td><td>0</td><td>1</td></tr> <tr><td>3-4</td><td></td><td>X</td></tr> <tr><td>3-4</td><td></td><td>X</td></tr> </table>	接點	0	1	3-4		X	3-4		X	<table border="1"> <tr><td>接點</td><td>0</td><td>1</td></tr> <tr><td>1-2</td><td>X</td><td></td></tr> <tr><td>1-2</td><td>X</td><td></td></tr> </table>	接點	0	1	1-2	X		1-2	X		<table border="1"> <tr><td>接點</td><td>0</td><td>1</td></tr> <tr><td>1-2</td><td>X</td><td></td></tr> <tr><td>3-4</td><td></td><td>X</td></tr> <tr><td>1-2</td><td>X</td><td></td></tr> <tr><td>3-4</td><td></td><td>X</td></tr> </table>	接點	0	1	1-2	X		3-4		X	1-2	X		3-4		X
接點	0	1																																																										
3-4		X																																																										
接點	0	1																																																										
1-2	X																																																											
接點	1	1																																																										
1-2	X																																																											
3-4		X																																																										
接點	0	1																																																										
3-4		X																																																										
3-4		X																																																										
接點	0	1																																																										
1-2	X																																																											
1-2	X																																																											
接點	0	1																																																										
1-2	X																																																											
3-4		X																																																										
1-2	X																																																											
3-4		X																																																										

照光式選擇開關三段接點圖

型 式	TN2-T1AA	TN2-T2AA																																
接 點	1a 0 1a	2a 0 2a																																
接 點 圖	<table border="1"> <tr><td>接點</td><td>1</td><td>0</td><td>2</td></tr> <tr><td>3-4</td><td>X</td><td></td><td></td></tr> <tr><td>3-4</td><td></td><td></td><td>X</td></tr> </table>	接點	1	0	2	3-4	X			3-4			X	<table border="1"> <tr><td>接點</td><td>1</td><td>0</td><td>2</td></tr> <tr><td>3-4</td><td>X</td><td></td><td></td></tr> <tr><td>3-4</td><td>X</td><td></td><td></td></tr> <tr><td>3-4</td><td></td><td></td><td>X</td></tr> <tr><td>3-4</td><td></td><td></td><td>X</td></tr> </table>	接點	1	0	2	3-4	X			3-4	X			3-4			X	3-4			X
接點	1	0	2																															
3-4	X																																	
3-4			X																															
接點	1	0	2																															
3-4	X																																	
3-4	X																																	
3-4			X																															
3-4			X																															

tend TN2 Ø22/Ø25/Ø30直接式指示燈

TN2

直接式指示燈所用燈泡種類與規格，同直接式照光按鈕開關，見TA78頁。

型號說明

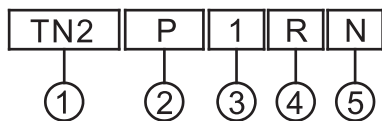

項次	代號	說明
1. 固定孔徑	TN2 TN3	Ø22mm/Ø25mm Ø30mm
2. 型式	P L N D	直接式 簡單式 (接線螺絲在後) 簡單式 (接線螺絲在二側) 大型LED

項次	代號	說明
3. 電壓	1	110VAC (霓虹、LED燈泡)
	2	220VAC (霓虹、LED燈泡)
	3	380VAC (霓虹燈泡)
	4	440VAC (霓虹燈泡)
	5	6VAC/DC (鎢絲、LED燈泡)
	6	18VAC/DC (鎢絲燈泡)
	7	24VAC/DC (鎢絲、LED燈泡)
	8	30VAC/DC (鎢絲、LED燈泡)
	9	12VAC/DC (鎢絲燈泡)
4. 顏色	R	紅
	G	綠
	O	橙
	W	白
	BL	藍
YG	黃綠	
5. 燈泡種類	I	鎢絲燈泡
	N	霓虹燈泡
	L	LED燈泡

指示燈裝配尺寸

TN2P 	TN3P
TN2L 	TN3L
TN2N 	TN3N
TN2D 	TN3D

直接式指示燈電源座接線圖及裝配尺寸

指示燈電源座接線圖及裝配尺寸

TNPS-1 	TNPS-2
-------------------	-------------------

tend TN2 Ø22/Ø25/Ø30指示燈

TN2

本系列指示燈為附變壓器，二次電壓全部為5V，一律使用鎢絲（6V）燈泡，見TA78頁。

型號說明

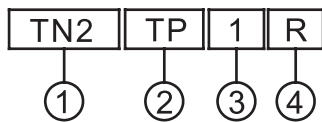

項次	代號	說明
1. 固定孔徑	TN2 TN3	Ø22mm/Ø25mm Ø30mm
2. 型式	TP	變壓器式

項次	代號	說明
3. 電壓	1	110V/5 VAC
	2	220V/5 VAC
	3	380V/5 VAC
	4	440V/5 VAC
4. 顏色	R	紅
	G	綠
	O	橙
	W BL	白 藍

指示燈上座部份裝配尺寸

TN2TP

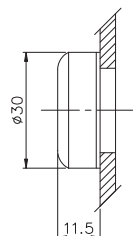

TN3TP

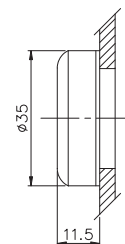

tend TN2 Ø22/Ø25/Ø30十字開關

TN2

型號說明

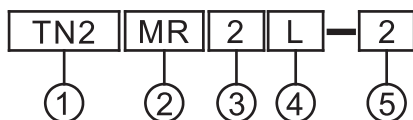

本系列開關之接點座依上下左右之方向印有UDLR，為十字開關專用，不可與其他開關混用

型號說明

項次	代號	說明
1. 固定孔徑	TN2 TN3	Ø22mm/Ø25mm Ø30mm
2. 型式	MR MZ	十字開關 十字開關(鋅合金接點座)
3. 方向	2 4	上下二方向 上下左右四方向
4. 操作方式	L R	保持 復歸
5. 接點數目	2 4 8	上下各1a 上下各2a或上下左右各1a 上下左右各2a

TN2MR2

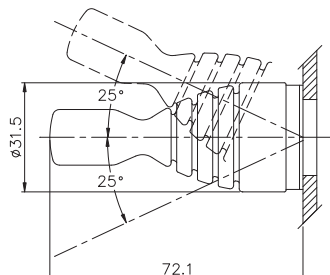

TN3MR4

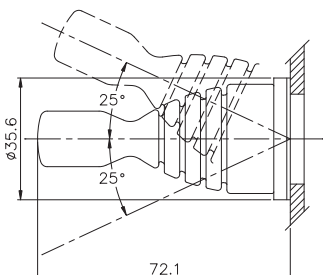
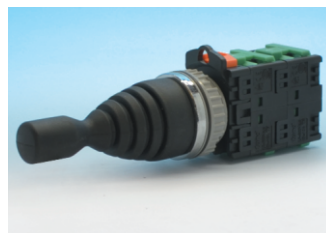

TN2MZ2

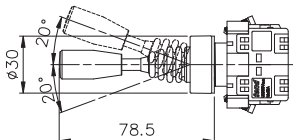
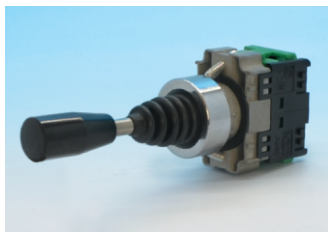

TN2MZ4

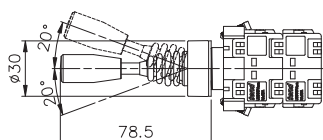
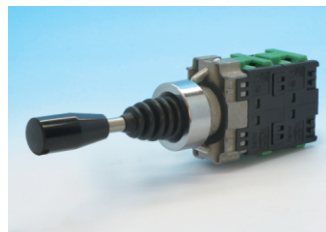

tend TN2 Ø22開關盒

TN2

本系列開關盒固定孔徑為Ø22mm,單孔開關盒有黃、灰二色,其餘全為灰色。接點座為專用型式,不同於Ø22/Ø30系列控制器材。上座部份之裝配尺寸、種類則於Ø22系列控制器材相同,開關盒使用之接點座型號TN2-B1A、TN2-B1B及TN2-B1C。

TN2-B1A

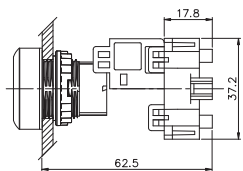
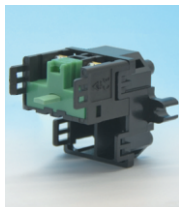

TN2-B1B

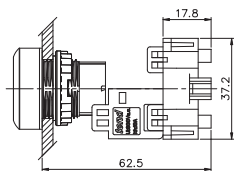

TN2-B1C

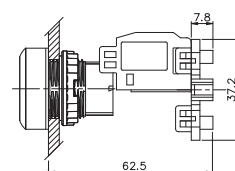

開關盒與開關之組立

- 1 將開關盒上蓋與下座拆開
- 2 將接點座固定於開關盒下座,將上座固定於開關盒上蓋。
- 3 將開關盒上蓋盒下座組合鎖上即成整組。

■ 本系列開關盒保護構造為IP65(IEC144)。

■ 用於開關盒上之所有照光式開關、指示燈,一律為直接式。

開關盒標準接點座 (接點圖同標準接點座,見TA76頁) ■ 開關盒照光式接點座 (接點圖同直接式照光接點座,見TA80頁)

TN2-B1ab • TN2-B2a • TN2-B2b

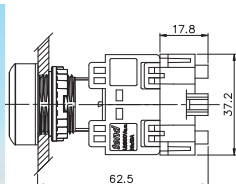
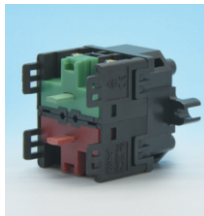

TN2-B1ab • TN2-B12a • TN2-B12b

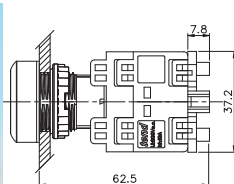

TN2-B2c

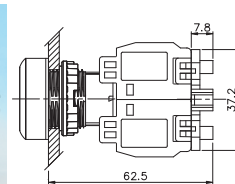

開關盒指示燈電源座 (接點圖同直接式指示燈,見TA87頁)

電纜固定頭外觀和尺寸 TPF21

TNPS-3

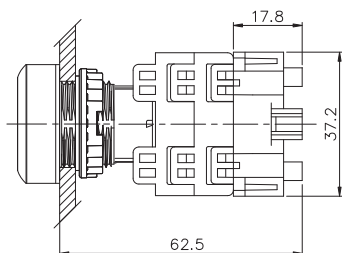

(適用電纜線徑: Ø6~Ø12) 工作溫度: -40℃~100℃

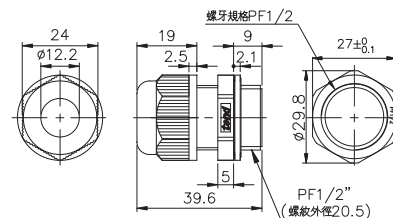

開關盒外觀與尺寸 (Ø22與Ø30系列,除固定孔徑不同外,其餘尺寸皆相同)

TN2-B1

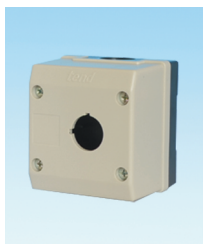

TN2-B2



TN2-B3



TN2-B4



TN2-B5

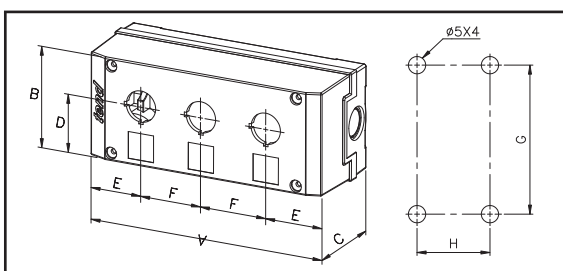

型 式	A	B	C	D	E	F	G	H
TN2-B1 TN3-B1	82	75	67.3	43.5	41	—	63	54
TN2-B2 TN3-B2	127	75	67.3	43.5	41	45	108	54
TN2-B3 TN3-B3	172	75	67.3	43.5	41	45	153	54
TN2-B4 TN3-B4	217	75	67.3	43.5	41	45	198	54
TN2-B5 TN3-B5	262	75	67.3	43.5	41	45	243	54

tend TN2 Ø22開關盒附開關

TN2

- 本系列開關盒附開關裝配孔徑為Ø22一種,其裝配之照光式、指示燈全為直接式。
- 大頭按鈕、連鎖式按鈕之開關盒為黃色及灰色,其餘為灰色。

一個開關 型號說明

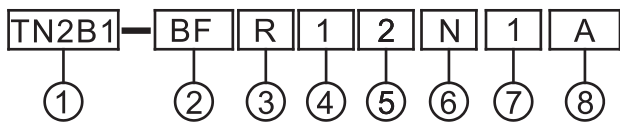

項次	代號	說明
1. 開關數	TN2B1	一個開關
2. 型式	BF	平頭按鈕
	BL	凸頭按鈕
	BM	大頭按鈕
	BK	連鎖式按鈕
	IF	平頭照光按鈕
	IL	凸頭照光按鈕
	IM	大頭照光按鈕
	IK	照光式連鎖按鈕
	S2	二段式選擇
	S3	三段式選擇

項次	代號	說明
3. 顏色	R	紅
	G	綠
	B	黑
4. 銘牌	1	OFF
	2	ON
	3	EM.STOP
	4	OFF-ON
	5	ON-OFF-ON
5. 電壓	1	110VAC (霓虹、LED燈泡)
	2	220VAC (霓虹、LED燈泡)
	3	380VAC (霓虹燈泡)
	4	440VAC (霓虹燈泡)
	5	6VAC/DC (鎢絲、LED燈泡)
	6	18VAC/DC (鎢絲燈泡)
	7	24VAC/DC (鎢絲、LED燈泡)
	8	30VAC/DC (鎢絲、LED燈泡)
	9	12VAC/DC (鎢絲燈泡)
6. 燈泡種類	I	鎢絲燈泡
	N	霓虹燈泡
	L	LED燈泡
7. 接點數目	1	1組
	2	2組
8. 接點種類	A	1a
	B	1b
	C	1a1b(選擇三段為1a 0 1a)
	AB	1a+1b

TN2B1-BFR1
TN2B1-IFR1



TN2B1-BFG2
TN2B1-IFG2



TN2B1-BLR1
TN2B1-ILR1



TN2B1-BLG2
TN2B1-ILG2



TN2B1-BMR3
TN2B1-IMR3



TN2B1-BKR3
TN2B1-IKR3



TN2B1-S2B4



TN2B1-S3B5



二個開關



型式	銘牌	開關種類	電壓	燈泡
TN2B2-BF	(上)ON(下)OFF	平頭按鈕(上)綠(下)紅		
TN2B2-IF2	(上)ON(下)OFF	平頭照光按鈕(上)綠(下)紅	220VAC	霓虹
TN2B2-IF7	(上)ON(下)OFF	平頭照光按鈕(上)綠(下)紅	24V	鎢絲

三個開關



型式	銘牌	開關種類	燈泡
TN2B3-BF	(上)ON(中)OFF(下)ON	平頭按鈕(上)綠(中)紅(下)綠	
TN2B3-IF	(上)ON(中)OFF(下)ON	平頭照光按鈕(上)綠(中)紅(下)綠	
TN2B3-PF2	(上)220V(中)ON(下)OFF	(上)指示燈紅色(中)平頭按鈕綠色(下)平頭按鈕紅色	霓虹
TN2B3-PF7	(上)24V(中)ON(下)OFF	(上)指示燈紅色(中)平頭按鈕綠色(下)平頭按鈕紅色	鎢絲

tend Ø22/Ø25/Ø30附件

TN2

■ 附件

TN2-BFW (TN2-BF/IF用)
防水套

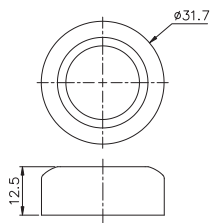

TN2-BTW (TN2-BT/IT用)
防水套

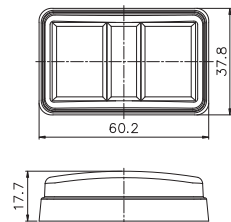

TN2-GR
圓形護蓋

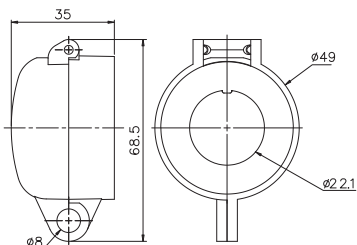

TN3-GR
圓形護蓋

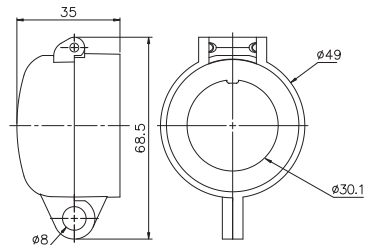

Ø22/Ø25/Ø30標示貼紙

■ 開關盒專用背膠貼紙

TBP、TBM

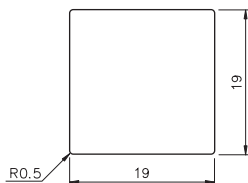

TN2-EA (連鎖式護座無印字)
TN2-EB (連鎖式護座)

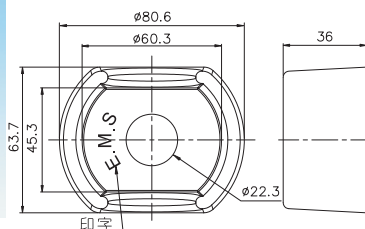

● 按鈕及照光式按鈕、指示燈用

TBP-01	TBP-02	TBP-03	TBP-04	TBP-05	TBP-06	TBP-07	TBP-08	TBP-09	TBP-10	TBP-11	TBP-12	TBP-13	TBP-14	TBP-15
○	I	II	III	IV	ON	OFF	START	STOP	UP	DOWN	SOURCE	HAND	AUTO	RUN
TBP-16	TBP-17	TBP-18	TBP-19	TBP-20	TBP-21	TBP-22	TBP-23	TBP-24	TBP-25	TBP-26	TBP-27	TBP-28	TBP-29	TBP-30
FWD	REV	CLOSE	OPEN	FAST	SLOW	RESET	EM.STOP	12V	24V	30V	110V	220V	B	1
TBP-31	TBP-32	TBP-33	TBP-34	TBP-35	TBP-36	TBP-37	TBP-38	TBP-39	TBP-40	TBP-41	TBP-42	TBP-43	TBM-01	TBM-02
2	3	4	5	6	7	8	9	INCH	➔	B1	B2		開	關
TBM-03	TBM-04	TBM-05	TBM-06	TBM-07	TBM-08	TBM-09	TBM-10	TBM-11	TBM-12	TBM-13	TBM-14	TBM-15	TBM-16	TBM-17
啓動	停止	電源	手動	自動	寸動	運轉	正轉	逆轉	高	低	快速	慢速	連鎖	上
TBM-18	TBM-19	TBM-20	TBM-21	TBM-22										
下	左	右	緊急	超載										

● 選擇開關用

TBP-51	TBP-52	TBP-53	TBP-54	TBP-55	TBP-56	TBP-57	TBP-58	TBP-59	TBP-60	TBP-61	TBP-62	TBP-63	TBP-64	TBP-65
○	II	○	III	ON	ON	ON	REV	REV	AUTO	AUTO	START	UP	UP	1
	I	○	III	OFF	ON	OFF	FWD	OFF	HAND	OFF	STOP	DOWN	DOWN	2
TBP-66	TBP-67	TBP-68	TBP-69	TBP-70	TBP-71	TBP-72	TBP-73	TBP-74	TBP-75	TBP-76	TBP-77	TBM-31	TBM-32	TBM-33
1	1	O	O	O	S	U	U	A	A	F	O	手動	手動	正轉
0	2	F	N	N	T	D	O	A	O	R	手動	停止	停止	逆轉
2	3	N	N	F	O	P	P	A	A	F	自動	自動	自動	
				O	S	W	F	O	O	W				
				N	T	O	N	A	A	D				
				F	O	P	P	O	O	V				
				N	T	O	N	A	A	D				
TBM-34	TBM-35	TBM-36	TBM-37	TBM-38	TBM-39	TBM-40	TBM-41	TBM-42	TBM-43	TBM-44	TBM-45	TBM-46		
正轉	運轉	上	上	開	啓動	停止	上下	上下	手動	手動	正轉	正轉		
停止	停止	下	下	關	停止	啓動	上下	上下	自動	自動	逆轉	逆轉		
逆轉	停止	下	下	關	停止	啓動	上下	上下	自動	自動	逆轉	逆轉		

tend Ø22/Ø25/Ø30標示銘牌

TN2

■ Ø22/Ø25/Ø30系列控制器材警示牌

警示牌 (黃色)

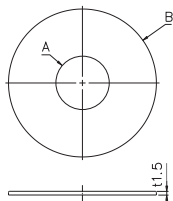

料號	品名	A	B
TN22E-01	22 小警示牌	Ø22	Ø60
TN25E-01	25 小警示牌	Ø25	Ø60
TN30E-01	30 小警示牌	Ø30	Ø60
TN22EL-01	22 大警示牌	Ø22	Ø90
TN25EL-01	25 大警示牌	Ø25	Ø90
TN30EL-01	30 大警示牌	Ø30	Ø90

警示牌 (STOP) (黃色黑字)

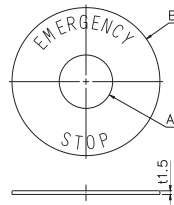

料號	品名	A	B
TN22E-02	22 小警示牌(STOP)	Ø22	Ø60
TN25E-02	25 小警示牌(STOP)	Ø25	Ø60
TN30E-02	30 小警示牌(STOP)	Ø30	Ø60
TN22EL-02	22 大警示牌(STOP)	Ø22	Ø90
TN25EL-02	25 大警示牌(STOP)	Ø25	Ø90
TN30EL-02	30 大警示牌(STOP)	Ø30	Ø90

■ Ø22/Ø25/Ø30系列控制器材壓克力銘牌 (P) 及鋁銘牌 (M)

TN22P- (22 塑膠銘牌) TN22M- (22 鋁銘牌)
 TN25P- (25 塑膠銘牌) TN25M- (25 鋁銘牌)
 TN30P- (30 塑膠銘牌) TN30M- (30 鋁銘牌)

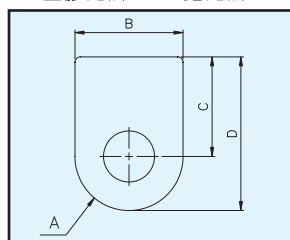

尺寸	A	B	C	D
TN22P	Ø22.3	41	32	52.5
TN22M	Ø22.2	31	27	42
TN25P	Ø25.5	41	32	52.5
TN25M	Ø24.9	31	27	42
TN30P	Ø30.5	41	32	52.5
TN30M	Ø30.3	38.5	32.5	52

01	02	03	04	05	06	07	08	09	10	11	12					
ON	OFF	START	STOP	UP	DOWN	SOURCE	MUNUEL	AUTO	RUN	FWD	REV					
13	14	15	16	17	18	19										
OFF	ON	ON	ON	ON	OFF	ON	FWD	REV	FWD	OFF	REV	AUTO	MANU	AUTO	OFF	MANU
20	21	22														
STOP	START	MANU	OFF	AUTO	1	0										
31	32	33	34	35	36	37	38	39								
開	關	啓動	停止	電源	手動	自動	寸動	運轉								
40	41	42	43													
手動	自動	手動	停止	自動	逆轉	正轉	逆轉	停止	正轉							
51	52	53	54	55	56	57	58	59								
开	关	启动	停止	电源	手动	自动	寸动	运转								
60	61	62	63													
手动	自动	手动	停止	自动	逆转	正转	逆转	停止	正转							
71	72	73	74													
○					○											

■ Ø22/Ø25/Ø30按鈕、照光按鈕用透明銘牌

TPP、TPM

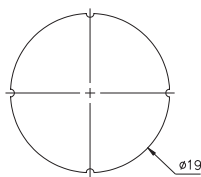

TPP-01	TPP-02	TPP-03	TPP-04	TPP-05	TPP-06	TPP-07	TPP-08	TPP-09	TPP-10	TPP-11
○					ON	OFF	START	STOP	UP	DOWN
TPP-12	TPP-13	TPP-14	TPP-15	TPP-16	TPP-17	TPP-18	TPP-19	TPP-20	TPP-21	TPP-22
SOURCE	HAND	AUTO	RUN	FWD	REV	CLOSE	OPEN	FAST	SLOW	RESET
TPP-23	TPP-24	TPP-25	TPP-26	TPP-27	TPP-28	TPP-29	TPP-30	TPP-31	TPP-32	TPP-33
INCH	12V	24V	30V	110V	220V	B	1	2	3	4
TPP-34	TPP-35	TPP-36	TPP-37	TPP-38	TPP-39	TPP-40	TPP-41	TPP-42	TPP-43	
5	6	7	8	9	→	B1	B2	B3	B4	
TPM-01	TPM-02	TPM-03	TPM-04	TPM-05	TPM-06	TPM-07	TPM-08	TPM-09	TPM-10	TPM-11
開	關	啓動	停止	電源	手動	自動	寸動	運轉	正轉	逆轉
TPM-12	TPM-13	TPM-14	TPM-15	TPM-16	TPM-17	TPM-18	TPM-19	TPM-20	TPM-21	TPM-22
高	低	快速	慢速	連鎖	上	下	左	右	緊急	超載