

Pilot Lamp

型號說明 Model Designation :

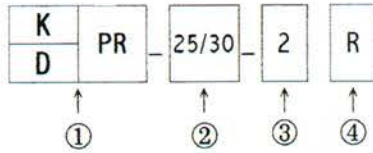

註 Note :

- 直接式不需經由變壓器(全電壓式)
The direct input type has no transformer for all range
- 閃光指示燈僅有 $\Phi 30\text{mm}$
Flashing Type Is $\Phi 30\text{mm}$ Only
- 耐電壓 AC2500V 一分鐘, 絕緣電阻 AC500V 之下, 100m Ω 以上
Dielectric strength AC2500V for 1 minute, and insulation resistance over 100m Ω under AC500V
- $\Phi 25\text{mm}$ 使用 E10、D10 燈泡, $\Phi 30\text{mm}$ 使用 E12、D12 燈泡
E10、D10 bulbs are for $\Phi 25\text{mm}$ series, and E12、D12 bulbs are for $\Phi 30\text{mm}$
- 為配合環保用料政策, 本系列產品之護圈恕不再提供電鍍, 如有需要請於訂購時註明
To comply with the environment protection policy, there would be no more plating for the protecting ring of the K series PB., PL., and Sw.. Please kindly notify with order if you still demand the plated rings

項次 Item	代號 Model No.	說明 Description								
1.孔徑 Diam	25	$\Phi 25\text{mm}$	D : LED							
	30	$\Phi 30\text{mm}$								
2.型式 Type	KPR(DPR)	Round Type	圓形指示燈 (LED)							
	KPQ(DPQ)	Square Type	方形指示燈 (LED)							
	KPM(DPM)	Round Type (Large $\Phi 60\text{mm}$)	中型指示燈 (LED)							
	KPL(DPL)	Round Type (Large $\Phi 80\text{mm}$)	特大指示燈 (LED)							
	KPRF(DPRF)	Flash Type (Round)	圓形閃光指示燈 (LED)							
	KPQF(DPQF)	Flash Type (Square)	方形閃光指示燈 (LED)							
	KPMF(DPMF)	Flash Type (Large $\Phi 60\text{mm}$)	中型閃光指示燈 (LED)							
	KPLF(DPLF)	Flash Type (Large $\Phi 80\text{mm}$)	特大閃光指示燈 (LED)							
3.電壓 Voltage	1	110V	2	220V	3	380V				
	4	440V	5	AC6.3V(DC)	6	AC18V(DC)				
	7	AC24V(DC)	8	AC30V(DC)	9	AC12V(DC)				
4.顏色 Color	R	紅色 Red	G	綠色 Green	O	橘色 Orange	W	白色 White	Bu	藍色 Blue

燈泡種類與規格 Lamp Types & Specification :



鎢絲燈泡
Tungsten

種類 TYPE	電壓 Voltage
E10-5 E12-5	6V
E10-6 E12-6	18V
E10-7 E12-7	24V
E10-8 E12-8	30V
E10-9 E12-9	12V



霓虹燈泡
Neon

種類 TYPE	電壓 Voltage	顏色 Color
E10-110-R、E12-110-R	110VAC	紅 RED
E10-110-G、E12-110-G	110VAC	綠 Green
E10-220-R、E12-220-R	220VAC	紅 RED
E10-220-G、E12-220-G	220VAC	綠 Green
E10-380-R、E12-380-R	380VAC	紅 RED
E10-380-G、E12-380-G	380VAC	綠 Green
E10-440-R、E12-440-R	440VAC	紅 RED
E10-440-G、E12-440-G	440VAC	綠 Green



LED

D10 : 6V、24V、110V、220V
D12 : 12V、18V、24V、110V、220V

種類 TYPE	晶粒 Crystalline	顏色 Color
D10-V-R D12-V-R	3	紅 RED
D10-V-G D12-V-G	1、2	綠 Green
D10-V-Y D12-V-Y	3	黃 Yellow
D10-V-W D12-V-W	2	白 White
D10-V-Bu D12-V-Bu	2	藍 Blue



Pilot Lamp

指示燈

• KPR-25

• DPR-25 (LED)

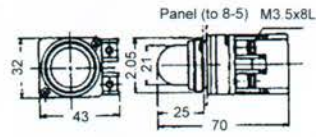

• KPR-30

• DPR-30 (LED)

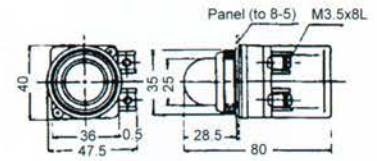

• KPQ-25

• DPQ-25 (LED)

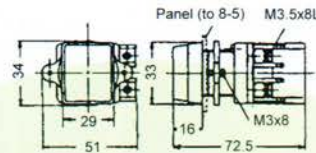

• KPQ-30

• DPQ-30 (LED)

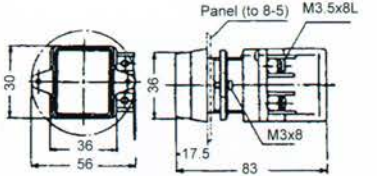

• KPF-25

• DPF-25 (LED)

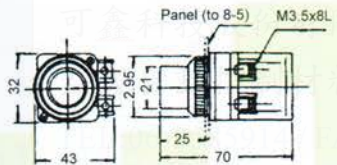

• KPF-30

• DPF-30 (LED)

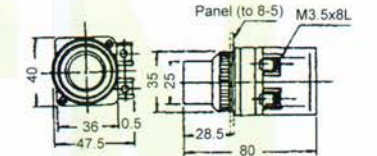

• KPRU-25

• DPRU-25 (LED)

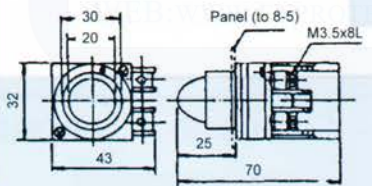

• KPRU-30

• DPRU-30 (LED)

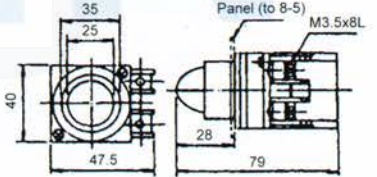

• KPFU-25

• DPFU-25 (LED)

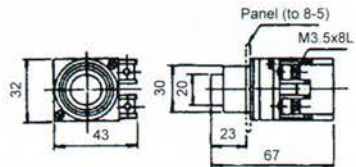

• KPFU-30

• DPFU-30 (LED)

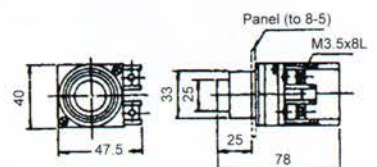

• KPM-25/30 • DPM-25/30 (LED) 60m/m
(\varnothing 25mm or \varnothing 30mm)

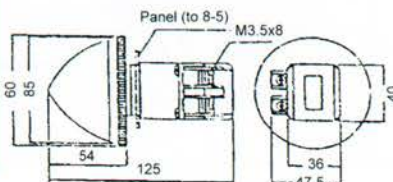

• KPL-30 • DPL-30 (LED) 80m/m

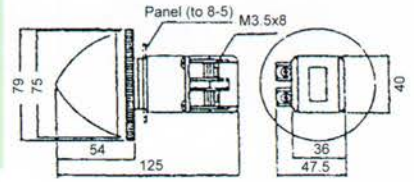

Pilot Lamp

指示燈

• ERN-25

• DRN-25 (LED)

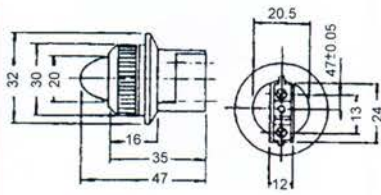

• ERN-30

• DRN-30 (LED)

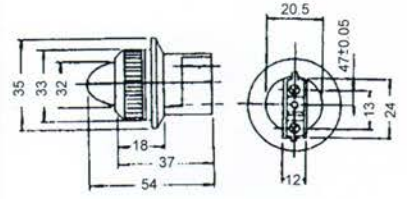

• EFN-25

• DFN-25 (LED)

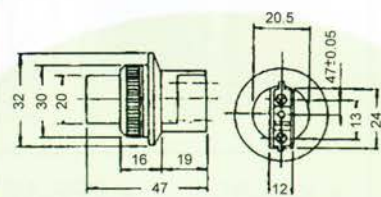

• EFN-30

• DFN-30 (LED)

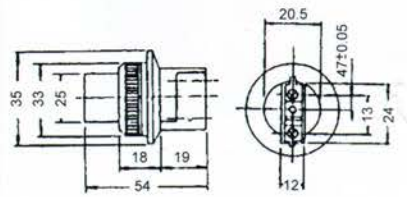

• ERUN-25

• DRUN-25 (LED)

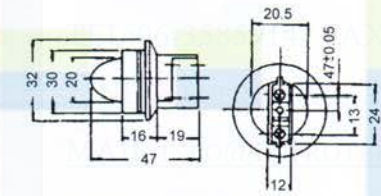

• ERUN-30

• DRUN-30 (LED)

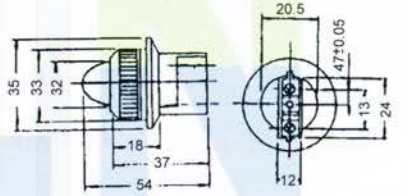

• EFUN-25

• DFUN-25 (LED)

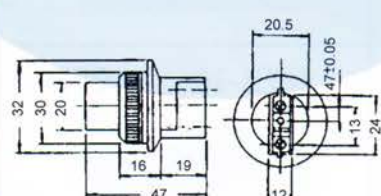

• EFUN-30

• DFUN-30 (LED)

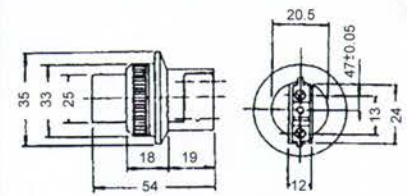
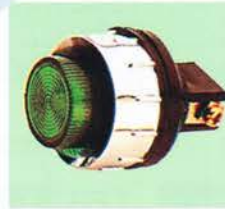

• ESN-25

• DSN-25 (LED)

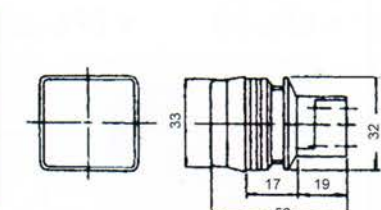

• ESN-30

• DSN-30 (LED)

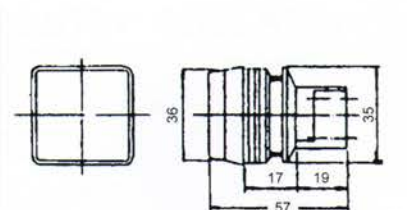

Pilot Lamp

指示燈

• KPRF-30

• DPRF-30 (LED)

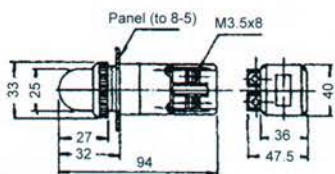

• KPFF-30

• DPFF-30 (LED)

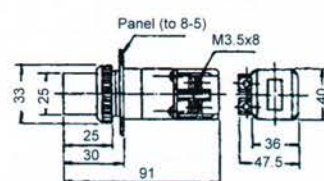

• KPRFU-30

• DPRFU-30 (LED)

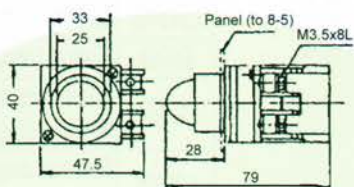

• KPFFU-30

• DPFFU-30 (LED)

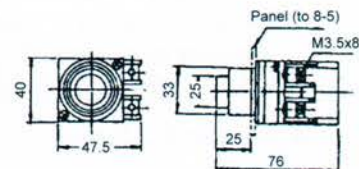

• KPSF-30

• DPSF-30 (LED)

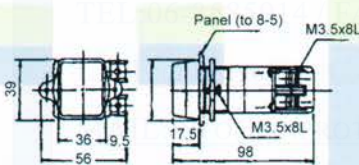

• KPLF-30

• DPLF-30 (LED) 80m/m

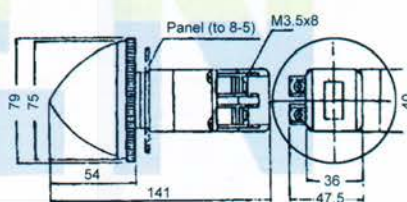

• KPMF-30

• DPMF-30 (LED) 60m/m

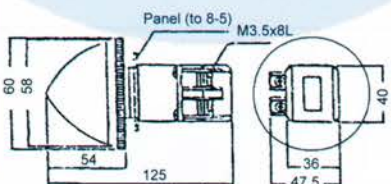

• D-200 (雷光燈) DC 6/12/24V AC 110/220V

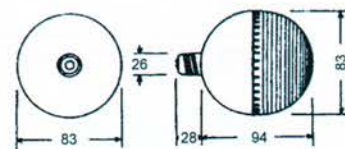

• D-300

DC 6/12/24V AC 110/220V

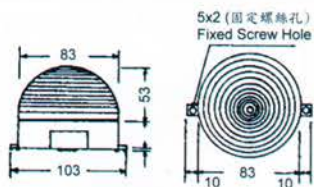

Push Button Switch

按
鈕
開
關

型號說明 Model Designation :

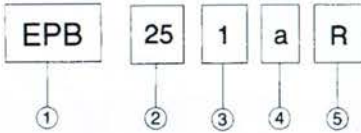

註 Note :

- 耐電壓 AC2500V 一分鐘
Dielectric Strength AC2500V for 1 Minute
- 絕緣電阻 AC500V 之下，100mΩ 以上
Over 100mΩ under AC500V
- 通電增溫 Temperature Rise :
接點低於 30°C At Contacts Less Than 30 °C
端子低於 25°C At Terminals Less Than 25 °C
(室溫 40°C，通電電壓 10Amp)
(Ambient Temperature 40 °C, continuous current 10 Amp)
- 周圍溫度 Ambient Temperature : -20°C ~ 60°C

規格 Specifications :

交流電 Alternate Current	AC125V 10A	AC250V 6A	AC500V 3A	AC600V 2A
直流電 Direct Current	DC125A 2A	DC250V 1A	DC600V 0.4A	

接點座尺寸 Contact Block Sizes :

接點種類 Type	長 Length	寬 Width	高 Height
1a1b	32.5	14.5	35
1a or 1b	32.5	14.5	26

項次 Item	代號 Model No.	說明 Description	
1.孔徑 Diam	25	Φ25mm	
	30	Φ30mm	
2.型式 Type	EPB	Flat Head	平頭
	OB	Protrude Head	凸頭
	MB	Mushroom Head	大頭
	WB	Waterproof Type	防水型
	RB	Latch Mushroom Head	連鎖式
	LRPB	Latch Extra Large Head	特大頭連鎖
	BPB	Extra Large Head	特大頭
	CB	Mushroom Head with Protecting Ring	護圈式
3.接點數 Contact	1	1 組 / 1 Set	
	2	2 組 / 2 Sets	
	3	3 組 / 3 Sets	
	4	4 組 / 4 Sets	
	4.接點種類 ContadType	(None)	1a1b (NO-NC)
A		1a (NO)	
B		1b (NC)	
5.顏色 Color	R	紅 Red	Y 黃 Yellow
	G	綠 Green	B 黑 Black



為配合環保用料政策，本系列產品之護圈恕不再提供電鍍，如有需要請於訂購時註明
To comply with the environment protection policy, there would be no more plating
for the protecting ring of the K series PB., PL., and Sw..
Please kindly notify with order if you still demand the plated rings

• EPB-251 (∅25mm) • EPB-301 (∅30mm)

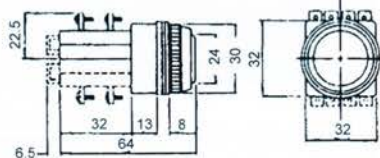

• RB-251 (∅25mm) • RB-301 (∅30mm)
RESET RESET

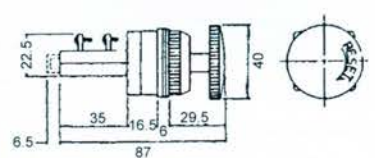

• MB-251 (∅25mm) • MB-301 (∅30mm)

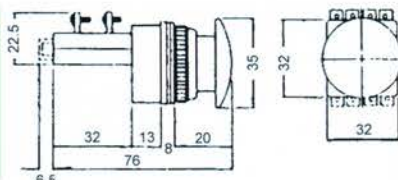

• LRB-251 (∅25mm) • LRB-301 (∅30mm)
RESET RESET

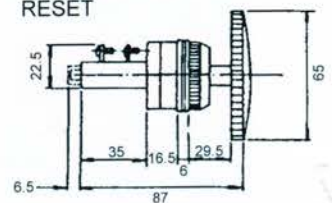



Push Button Switch

按鈕開關

- OB-251 (∅25mm)
- OB-301 (∅30mm)

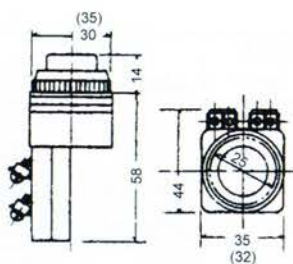
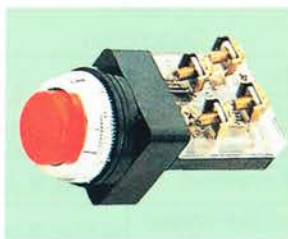

- MBM-301

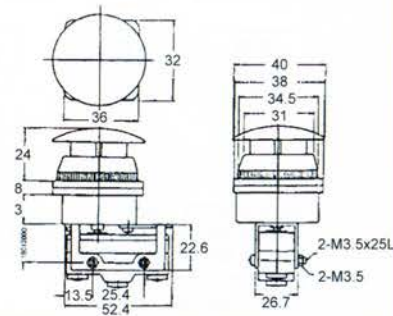

- WB-251 (∅25mm)
- WB-301 (∅30mm)

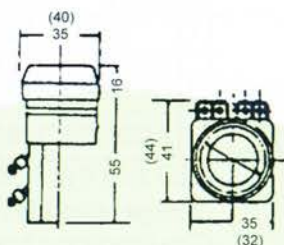
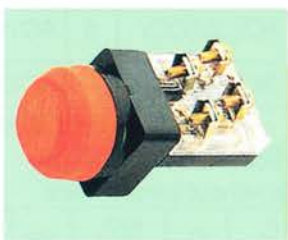

- EPBM-301

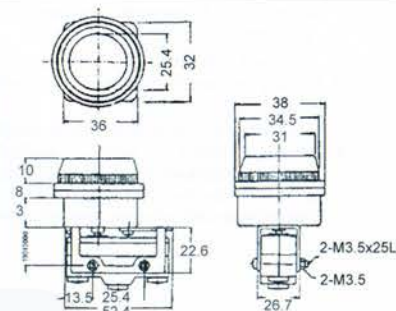

- UB-251 (∅25mm)
- UB-301 (∅30mm)

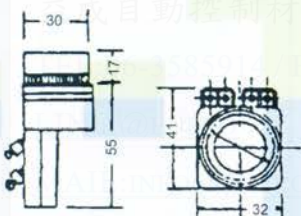

- UMB-301

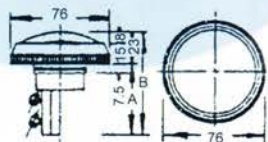
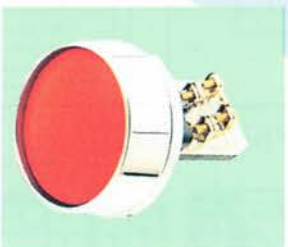

- CB-301

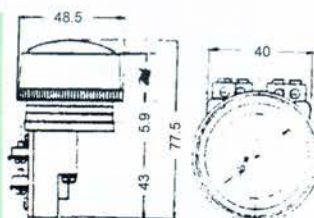
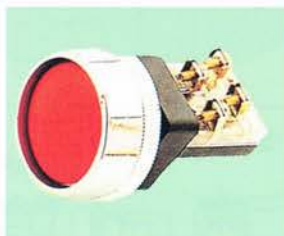

- UWB-301 (防雨型)

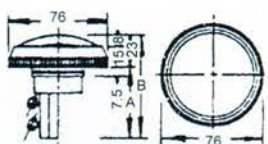
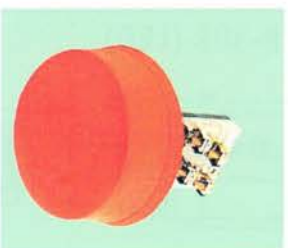

- BPB-301

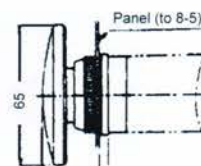
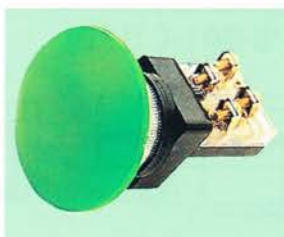

Illuminate Push Button Switch

型號說明 Model Designation :

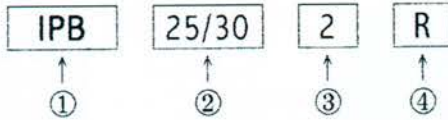

註 Note :

- 耐電壓 AC2500V 一分鐘
Dielectric Strength AC2500V for 1 Minute
- 絕緣電阻 AC500V 之下，100mΩ 以上
Over 100mΩ under AC500V
- 通電增溫 Temperature Rise :
接點低於 30°C At Contacts Less Than 30°C
端子低於 25°C At Terminals Less Than 25°C
(室溫 40°C，通電電壓 10Amp)
(Ambient Temperature 40°C, continuous current 10 Amp)
- 周圍溫度 Ambient Temperature : -20°C ~ 60°C
- 接點座規格及尺寸請參考 P.29
Please Refer to P.29 for Specifications and Sizes of Contact Blocks
- 為配合環保用料政策，本系列產品之護圈恕不再提供鍍鍍，如有需要請於訂購時註明
To comply with the environment protection policy, there would be no more plating for the protecting ring of the K series PB., PL., and SW.
Please kindly notify with order if you still demand the plated rings

項次 Item	代號 Model No.	說明 Description					
1.孔徑 Diam	25	Φ25mm		D : LED			
	30	Φ30mm					
2.型式 Type	IPB(DIPB)	Standard Illuminated		標準照光式			
	NPB(DNPB)	Neon Illuminated		霓虹照光式			
	IPBU (DIPBU)	Standard Illuminated with Protecting Ring		護圈標準照光式			
	NPBU (DNPBU)	Neon Illuminated with Protecting Ring		護圈霓虹照光式			
3.電壓 Voltage	1	110V	2	220V	3	380V	
	4	440V	5	AC6.3V(DC)	6	AC18V(DC)	
	7	AC24V(DC)	8	AC30V(DC)	9	AC12V(DC)	
	LED 燈泡可由 AC6V ~ AC220V，直接式不附變壓器 Voltage of the LED is from AC6V to AC220V The direct input type is without transformers						
	4.顏色 Color	R	紅色 Red	G	綠色 Green	○	橙色 Orange
						W	白色 White

• IPB-25

• DIPB-25 (LED)

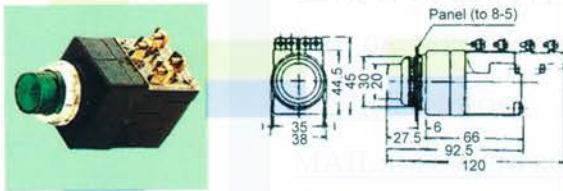

• IPB-30

• DIPB-30 (LED)



• NPB-25

• DNPB-25 (LED)

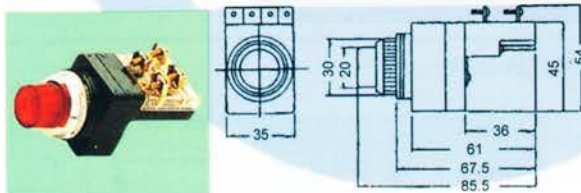

• NPB-30

• DNPB-30 (LED)

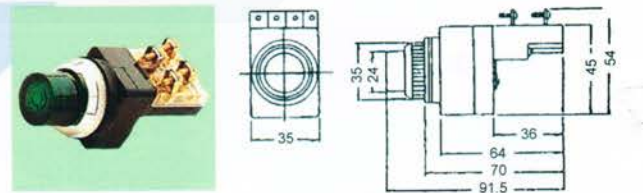

• IPBU-25

• DIPBU-25 (LED)

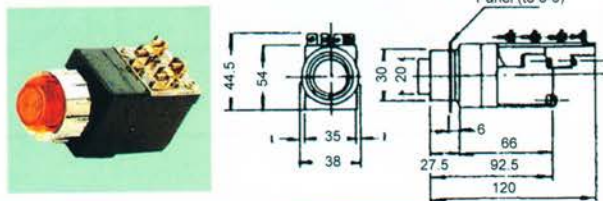

• IPBU-30

• DIPBU-30 (LED)

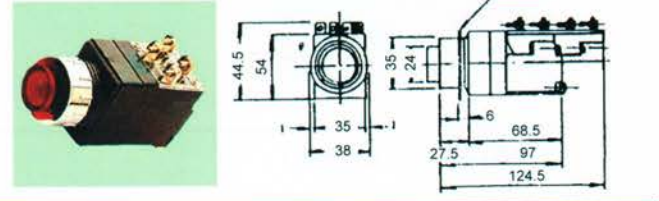

• IPB-301-C

• DIPB-301-C (LED)

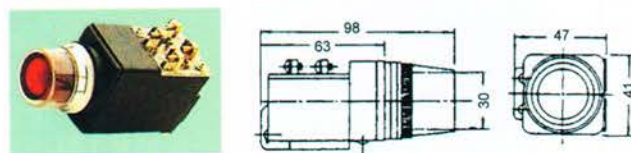

• IPB-303

• DPB-303 (LED)

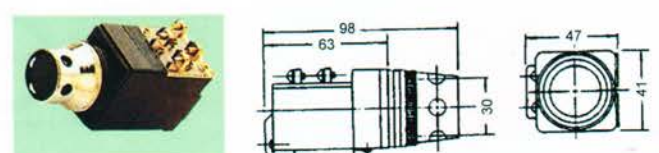

Selector Switch

選擇開關

型號說明 Model Designation :

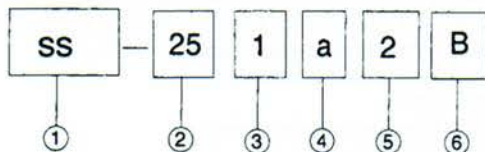

註 Note :

- 耐電壓 AC2500V 一分鐘
Dielectric Strength AC2500V for 1 Minute
- 絕緣電阻 AC500V 之下，100mΩ 以上
Over 100mΩ under AC500V
- 通電增溫 Temperature Rise :
接點低於 30°C At Contacts Less Than 30°C
端子低於 25°C At Terminals Less Than 25°C
(室溫 40°C，通電電壓 10Amp)
(Ambient Temperature 40°C, continuous current 10 Amp)
- 周圍溫度 Ambient Temperature : -20°C ~ 60°C
- 鑰匙開關恕不提供顏色選擇
No Color Selection Available for Key Selector Switches
- 接點座規格及尺寸請參考 P.29
Please Refer to P.29 for Specifications and Sizes of Contact Blocks
- 為配合環保用料政策，本系列產品之護圈恕不再提供電鍍，如有需要請於訂購時註明
To comply with the environment protection policy, there would be no more plating for the protecting ring of the K series PB., PL., and SW.
Please kindly notify with order if you still demand the plated rings

項次 Item	代號 Model No.	說明 Description	
1.孔徑 Diam	25	Φ25mm	
	30	Φ30mm	
2.型式 Type	SS	Selector Switch	選擇開關
	KS	Key Selector	鑰匙開關
	LS	Long Handle Selector	長柄選擇開關
3.接點數 Contact Block	1	1 組/ 1 Set	
	2	2 組/ 2 Sets	
	3	3 組/ 3 Sets	
	4	4 組/ 4 Sets	
4.接點種類 Contact Type	(None)	1a1b (NO-NC)	
	A	1a (NO)	
	B	1b (NC)	
5.段數 Phases	2	2 段/ 2 Phases	
	3	3 段/ 3 Phases	
6.顏色 Color	R	紅 Red	
	G	綠 Green	
	B	黑 Black	

• SS-25

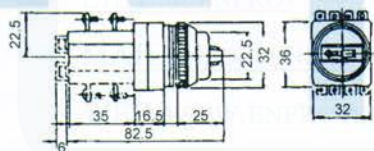

• SS-30

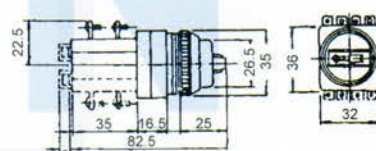

• LS-25

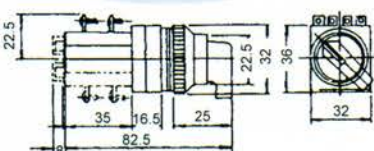

• LS-30

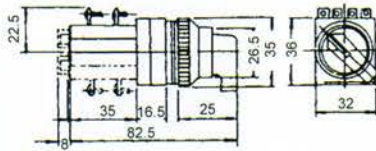

• KS-25

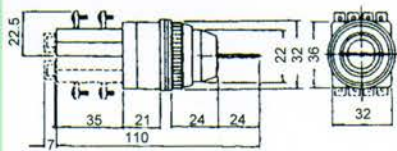
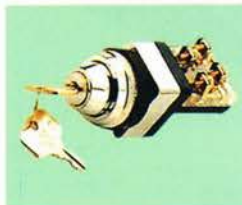

• KS-30

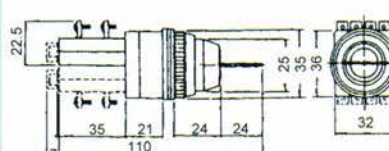
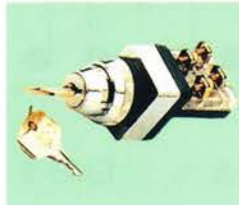

Monolever Switch

十字型選擇開關

型號說明 Model Designation :

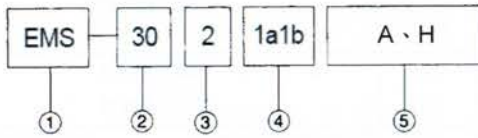

項次 Item	代號 Model No.	說明 Description
1. 型式 Type	EMS	圓形 Round
2. 孔徑 Diam	30	Φ30mm
3. 方向 Direction	2 4	雙向 2 Ways 四向 4 Ways
4. 接點種類 Contact Type	1a 1a1b 2a 2a2b	1NO 1NO1NC 2NO 2NO2NC
5. 作動方式 Activation	A H	自動 Automatic 手動 Manual

特色 Feature :

- 可靈活且迅速地藉由操作桿控制四方向之動作。
Able to smoothly and swiftly handle the lever in 4 directions, up, down, left, and right.
- 每個方向之操作皆有三種方式可任意選擇：位置保持、自動復歸、動作阻止。
Three additional alternative movements in each direction, position keep, spring return, and blockade-enforcing.
- 開關可作二、三、四方向之操作。
Free to operate in 2, 3, or 4 directions with the switch.
- 橡膠襯套有防雨、防油及防塵之作用。
Rubber bushing is rainproof, oil resistant, and dust preventive.

交流電 Alternate Current	額定電壓 Rated Voltage	110V	220V	440V	
	額定電流 Rated Current	5A	3A	1A	
開斷電流 Breaking Current Capacity	50A	30A	10A		
	10A				
直流電 Direct Current	阻絕值 Resistance Load	額定電壓 Rated Voltage	110V	220V	440V
		額定電流 Rated Current	2.2A	1.1A	0.4A
		開斷電流 Breaking Current	2.42A	1.21A	0.44A
	感應值 Inductive Load	額定電流 Rated Current	1.2A	0.45A	0.2A
		開斷電流 Breaking Current	1.32A	0.5A	0.22A
		持續通電電流 Continuous Passable Current	10A		
絕緣電阻 Insulation Resistance	100mΩ 以上				
耐電壓 Dielectric Strength	AC2,200V 一分鐘				
壽命 Service Life	AC2,200V for 1 minute				
使用環境溫度 Ambient Temperature	機械式與電氣式皆為 500,000 次				
		500,000 times both mechanical and electrical			
		-20℃ ~ 50℃			

訂購說明事項 Order Instruction :

請依順時針方向指定各方向之操作方式及接點構造
Please kindly designate movement way and contact block type clockwise.



EMS接點座 / EMS Contact Block



EMS302

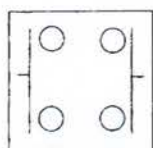
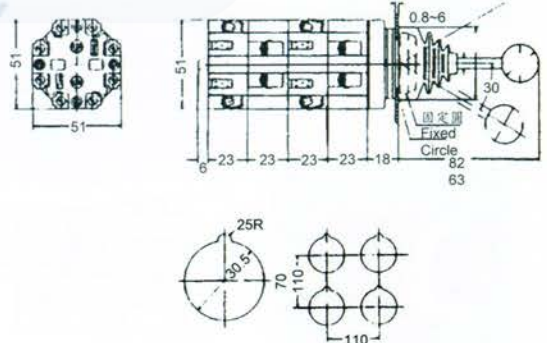

EMS-1

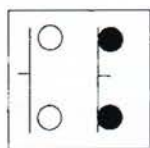

EMS-2

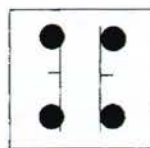

EMS-3



十字型操作開關接點數可依需求串接
Number of Contact Blocks Is Extendable as Per Your Demand