

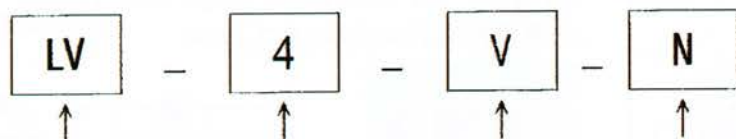

Flat Lamp

記名式指示燈

型號說明 Model Designation :



記名式指示燈 Flat Lamp	4 - 4 燈Lamps 6 - 6 燈Lamps 8 - 8 燈Lamps	電壓 Voltages 18V 24V 30V 110V 220V	U : 鎢絲燈泡 Tungsten Lamp N : 霓虹燈泡 Neon Lamp D : LED 使用 D12 燈泡，規格請參考 P.23 Applying D12 bulbs, see p.23 for specifications
---------------------	--	--	--

1. 電壓 Voltage : 18V、24V、30V、110V、220V
2. 可由 4 燈延伸追加至 100 燈
Number of flat lamp is able to extend from 4 to 100 lamps
3. 訂購時請說明面板配置 (如 4x4 或 6x6)
Please kindly designate the panel configuration when placing an order (i.e. 4x4 or 6x6)
4. 每燈可區分色別，及附印加字
Each lamp can be distinguished by color, and lettered
5. 燈泡可分：鎢絲、霓虹、LED 燈泡
Bulbs available : tungsten, neon, and LED

• LV-4

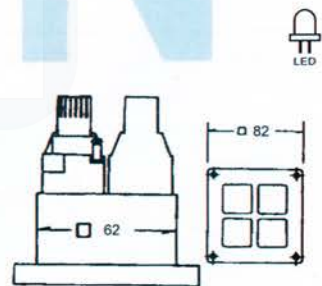
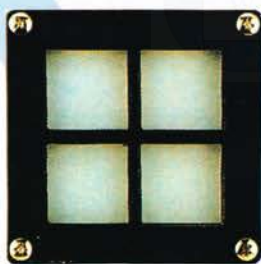

• LV-6

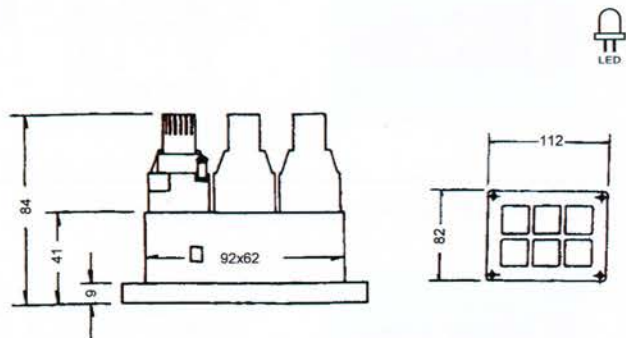



Neon Lamp

小型霓虹指示燈

• EFUN-12 6V~220VAC (12 \varnothing mm)

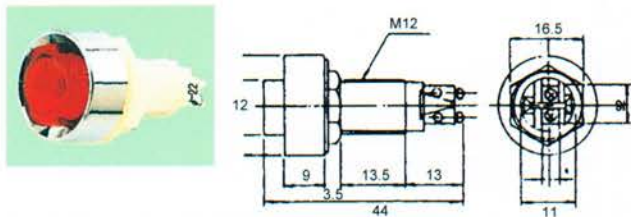

• EFN-16 6V~220VAC (14 \varnothing mm) 可用LED
平圓型 Flat Head Round Type LED Compatible

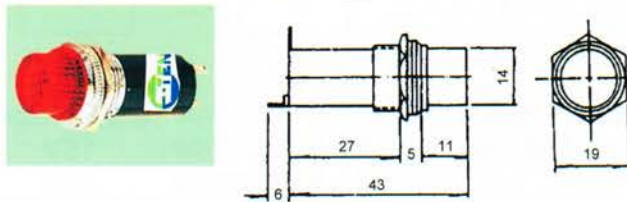

• EPN-16 6V~220VAC (15 \varnothing mm) 可用LED
鑽石型燈頭 Diamond Head LED Compatible

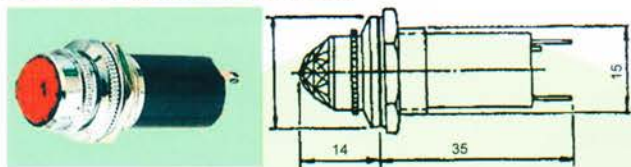

• EPN-14 6V~220VAC (15 \varnothing mm)

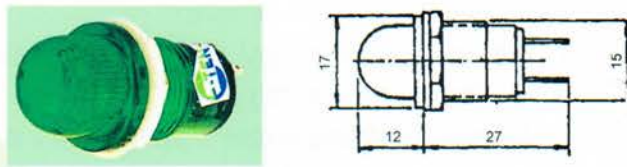

• EFN-10 6V~220VAC (10 \varnothing mm)
平方型 Flat Head Square Type



• EFRN-10 6V~220VAC (10 \varnothing mm)
平圓型 Flat Head Round Head



• EPN-10 6V~220VAC (10 \varnothing mm)



• EPN-8 6V~220VAC (8 \varnothing mm)

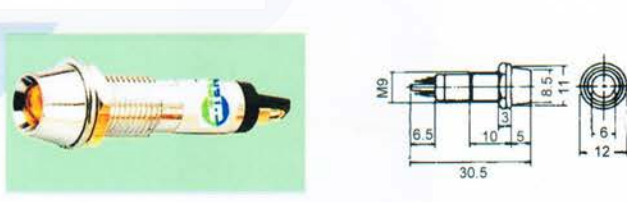

• EPN-772 6V~220VAC (10 \varnothing mm)

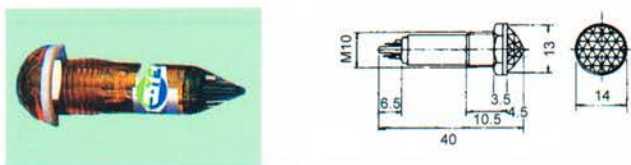

• EPN-778 6V~220VAC (15 \varnothing mm)

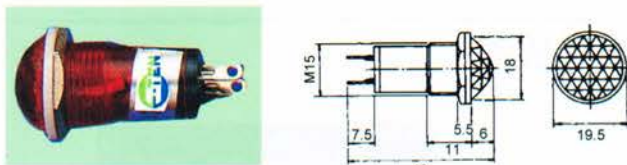

• EPN-768 6V~220VAC (10 \varnothing mm)

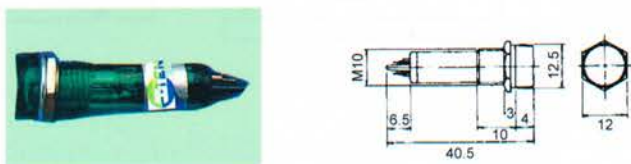

• EPN-376 6V~220VAC





Miniature Push Button Switch

小型按鈕開關



PB-101A OFF-(ON)
PB-101B ON-(OFF)
()為交替 () Means Momentary
材質 Material: 銅 Copper、塑膠 Plastic
顏色 Color: 黑 Black
額定值 Rated Capacity: AC125V、1A、Φ7.2mm

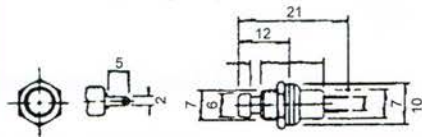

DS-139 交替開關 Push On & Push Off
顏色 Color: 紅 Red、黑 Black
額定值 Rated Capacity: AC250V、6A、Φ10mm
迴路 Circuit: 2P (SPST)

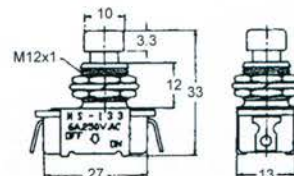

PB-301A ON-OFF
PB-301B OFF-(ON)
()為交替 () Means Momentary
顏色 Color: 紅 Red、橙 Orange、黃 Yellow
綠 Green、藍 Blue、黑 Black、白 White
額定值 Rated Capacity: AC125V、3A、Φ12mm



PB-304A ON-OFF
PB-304B OFF-(ON)
()為交替 () Means Momentary
顏色 Color: 紅 Red、橙 Orange、黃 Yellow
綠 Green、藍 Blue、黑 Black、白 White
額定值 Rated Capacity: AC125V、3A、Φ12mm

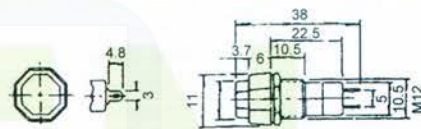

PB-303A ON-OFF
PB-303B OFF-(ON)
()為交替 () Means Momentary
顏色 Color: 紅 Red、橙 Orange、黃 Yellow
綠 Green、藍 Blue、黑 Black、白 White
額定值 Rated Capacity: AC125V、3A、Φ12mm

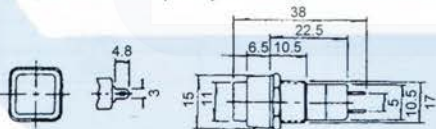

PB-308A ON-OFF
PB-308B OFF-(ON)
()為交替 () Means Momentary
顏色 Color: 紅 Red、橙 Orange、黃 Yellow
綠 Green、藍 Blue、黑 Black、白 White
額定值 Rated Capacity: AC125V、3A、Φ12mm

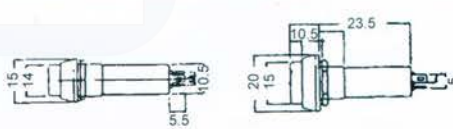

PB-305A ON-OFF
PB-305B OFF-(ON)
()為交替 () Means Momentary
顏色 Color: 紅 Red、橙 Orange、黃 Yellow
綠 Green、藍 Blue、黑 Black、白 White
額定值 Rated Capacity: AC125V、3A、Φ12mm

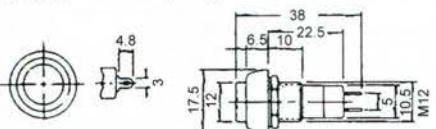

EB-5151 塑架 Plastic Frame Φ12mm
EB-5252 鐵架 Iron Frame

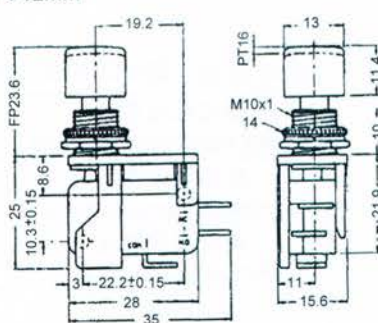

EB-6161 塑架 Plastic Frame Φ12mm
EB-6262 鐵架 Iron Frame

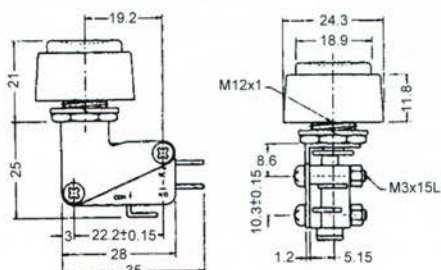

EB-8181

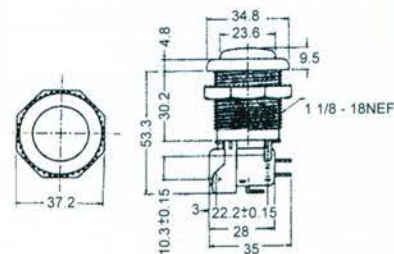

Miniature Pilot Lamp、Buzzer Push Button、Selector Switch



16Φ 產品系列 16Φ Series Product :

可精確動作和密集操作，採組合接點，能同時多項控制，適用於電子、電腦週邊、事務機械、通信、精密機械操作與控制。

Designed for precision and miniature operations, and the assembly contact block can be applied with multiple control. Especially suitable for electronics devices, computer peripherals, business machines, communications, and operation and control of precision machineries.

型號說明 Model Designation :

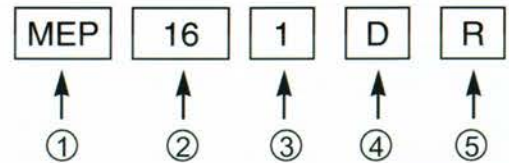

MEI(T) I-按鈕(復歸型) I-Push Button (Spring Return)
T-押扣(交替型) T-Push Button (Momentary)

接點可依需要組合 Contact Block Available
1ab ~ 4ab (焊接式 Soldering Type)

接點 Contact Block	長度 Length
1ab	39.8mm
2ab	47.3mm
3ab	54.8mm
4ab	62.3mm

項次 Item	代號 Model No.	說明 Description	
1.孔徑 Diam	16	Φ16mm	
2.型式 Type	MEP	Pilot Lamp	指示燈
	MBI(T)	Push Button	按鈕(押扣)
	MEI(T)	Illuminated Push Button	照光式按鈕(押扣)
	LBI(T)	Emergency Push Button	大頭緊急按鈕(押扣)
	LEI(T)	Illuminated Emergency PB.	照光大頭緊急按鈕
	MES	Selector Switch	選擇開關
	MKS	Key Selector	附鎖選擇開關
	MBL	Buzzer	蜂鳴器
MIBL	Buzzer with Lamp	照光蜂鳴器	
3.電壓 Voltage	A1	AC110V	A2 AC220V L5 LED 6V
	L6	LED 12V	L7 LED 24V D5 DC6V
	D6	DC14V	D7 DC28V
4.外形 Shape	1	圓形 Round	
	2	方形 Square	
	3	長方形 Rectangular	
4.顏色 Color	R	紅色 Red	G 綠色 Green
	O	橘色 Orange	W 白色 White
	B	藍色 Blue	Y 黃色 Yellow

特定值表 Specifications

額定絕緣電壓 Rated Insulation Voltage	AC DC 500V
使用周圍溫度 Ambient Temperature	-20°C ~ 70°C
使用周圍溼度 Ambient Humidity	45% ~ 85%
壽命 Service Life	機械 Mechanical: 250,000 次 Times 電氣 Electrical: 100,000 次 Times
耐電壓 Dielectric Strength	AC2500V 一分鐘 AC2500V for 1 Minute
絕緣阻抗 Insulation Resistance	DC500V 以下, 100mΩ 以上 Over 100mΩ under DC500V

額定值表 Rated Capacity

代號 Model No.	電流 Current	電力 Power
A1	1A	
A2	0.7A	
L5	19mA	
L6	21mA	
L7	18mA	
D5	200mA	0.4W
D6	80mA	0.5W
D7	40mA	0.7W

Miniature Pilot Lamp、Buzzer Push Button、Selector Switch

外觀尺寸與面板安裝 Panel Size and Installation (單位Measurement : mm)

指示燈與按鈕開關 Pilot Lamp and Push Button

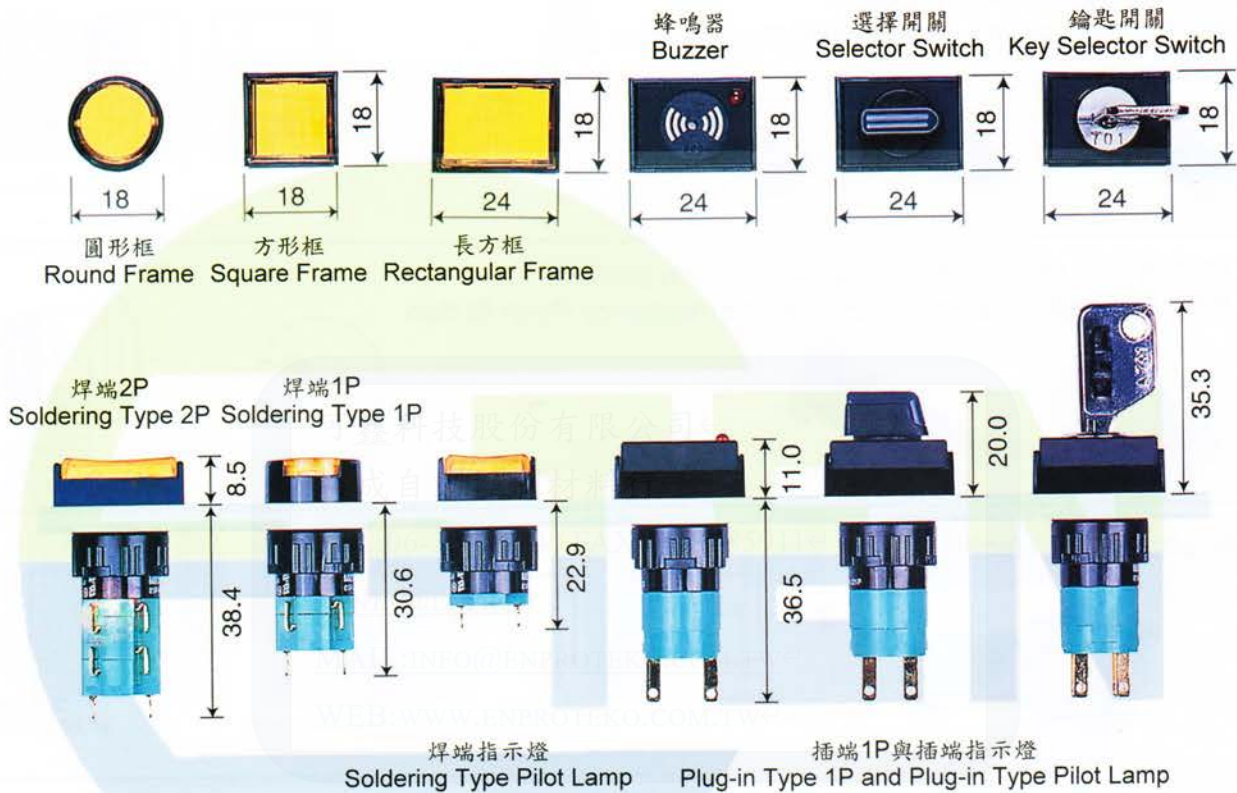

面板後尺寸 Sizes Behind the Panel 面板厚度最大尺寸 : 6.5 Max. Panel Thickness Sizes : 6.5

面板安裝及安裝孔徑 Panel Installation and Installation Diameter

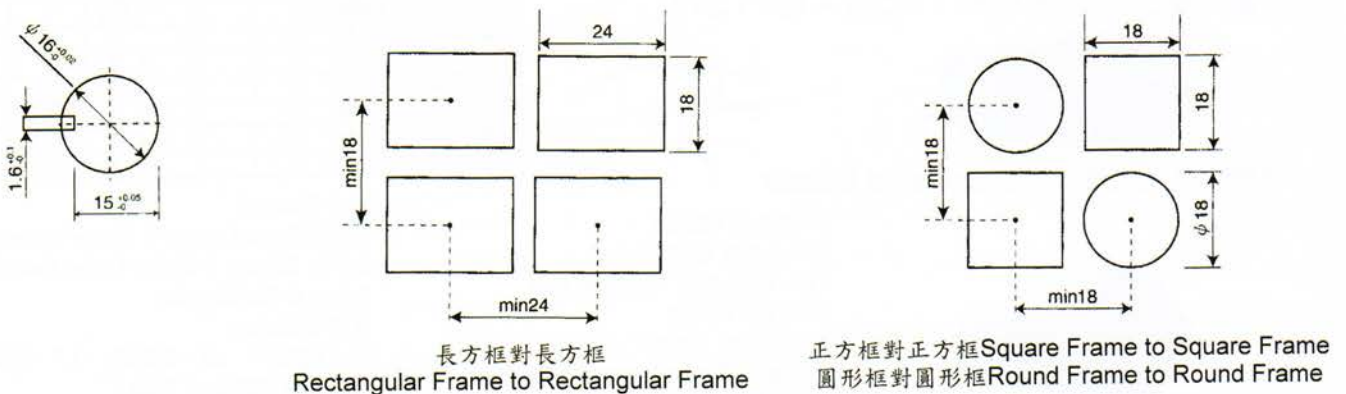

迷你型指示燈、蜂鳴器、選擇開關及按鈕開關

Miniature Pilot Lamp、Buzzer Push Button、Selector Switch

迷你型指示燈、蜂鳴器、選擇開關及按鈕開關

MEP指示燈Pilot Lamp

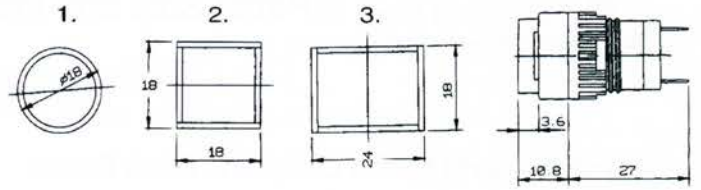

MBI(T)按鈕(押扣)Push Button
MEI(T)照光按鈕(押扣)Illuminated Push Button

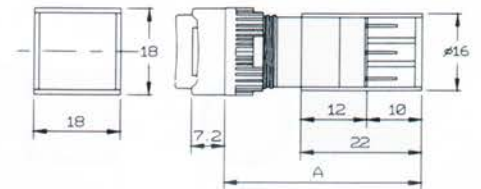

LBI(T)緊急大頭按鈕(押扣)Emergency Push Button
LEI(T)緊急照光按鈕(押扣)Illuminated Emergency Push Button

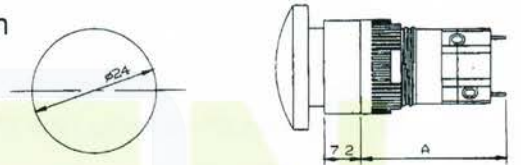

MES選擇開關Selector Switch

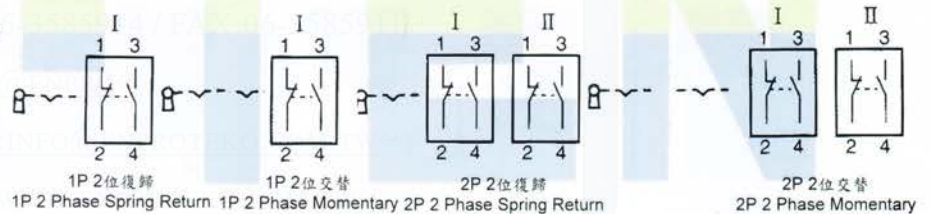

MKS附鎖選擇開關Key Selector Switch



接點模式 Contact Type	1 Pole : 1a1b, 2 Poles : 2a2b
致動行程 Activation	2 位 2 Phase L90° - V90°
致動力道 Operation Force	1 Pole 2.5Ncm - 2 Pole 5.5Ncm
壽命 Service Life	50,000 次 50,000Times
重量 Weight	焊端 1P 26gw、2P 27gw、插端 1P 27gw (皆含鑰匙) Soldering Type 1P 26gw, 2P 27gw Plug-in Type 1P 27gw (Key included in all types)

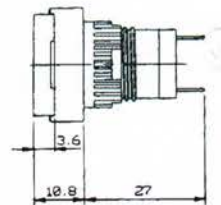

MBL蜂鳴器Buzzer
(輸入電壓Voltage Input : DC6V、12V、24V)

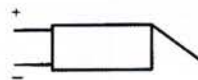

型號 Model No.	間歇 Interim	連續 Continuous	LED	插端 Socket	焊接 Soldering
MIBL-16-3-I-L7-FR	V	X	FR	V	X
MIBL-16-3-C-L7-R	X	V	R	V	X
MIBL-16-3-C-L7-Y	X	V	Y	V	X
MBL-16-3-I-L7-SK	V	X	X	V	X
MBL-16-3-C-L7-SK	X	V	X	V	X
MBL-16-3-I-L7-SD	V	X	X	X	V
MBL-16-3-C-L7-SD	X	V	X	X	V

MIBL照光式蜂鳴器Illuminated Buzzer



I : 間歇聲 Interim
C : 連續聲 Continuous
FR : LED 閃紅 Flashing Red
R : LED 紅 Red
Y : LED 黃 Yellow
額定電流 Rated Current : Maximum 7mA
音量 Volume : 70dB
距離 Distance : 30M

外形 Shape :
1.圓形 Round (開發中 Under Development)
2.方形 Square (開發中 Under Development)
3.長方形 Rectangular
電壓 Voltage :
L5 : DC6V、L6 : DC12V、L7 : DC24V
端腳類型 Terminal Type :
SK : 插端 Socket
SD : 焊接 Soldering