



Power Controls



Push Buttons
Selector Switches
Pilot Lights





安規標準→	通過CSA認證及CE/EN60947-5-1, 標準
電氣容量→	最大絕緣電壓 600VAC, 最大熱電流 10A
操作類別→	AC15類: 250VAC / 6A, DC13類: 250VDC / 0.6A
觸點導阻→	最大50MΩ
絕緣強度→	2500VAC 50Hz, 1分鐘
絕緣阻抗→	500VDC下, 大於100MΩ
耐震阻值→	10g @40-500Hz
用燈壽命→	白熾燈 1,000小時, LED燈 100,000小時
機械壽命→	按鈕開關: 瞬間 > 3,000,000 維持 > 500,000
	選擇開關: 瞬間 > 500,000 維持 > 500,000
	鑰匙開關: 瞬間 > 500,000 維持 > 500,000
	緊急開關: > 300,000
電氣壽命→	開關片AC15 250VAC / 6A > 1,000,000
	DC13 250VAC / 0.6A > 1,000,000
儲存溫度→	- 40°C to 70°C
操作室溫→	- 25°C to 70°C

TYPE NUMBER NOMENCLATURE

尺寸		ψ22	ψ25	ψ30
D	面板孔徑	22.5	25.5	30.5
A	標準頭部	45min	45min	45min
	長柄選擇	50	50	50
	二點照光按鈕	60	60	60
	ψ60大頭按鈕	61	61	61
	十字開關	70	70	70
B	標準頭部(圓型、方型)	31 (51)	31 (51)	40 (51)
	長柄選擇	35 (51)	35 (51)	40 (51)
	二點式照光按鈕	31 (51)	31 (51)	31 (51)
	ψ40大頭按鈕	41 (51)	41 (51)	41 (51)
	ψ60大頭按鈕	61	61	61
	十字開關	70	70	70

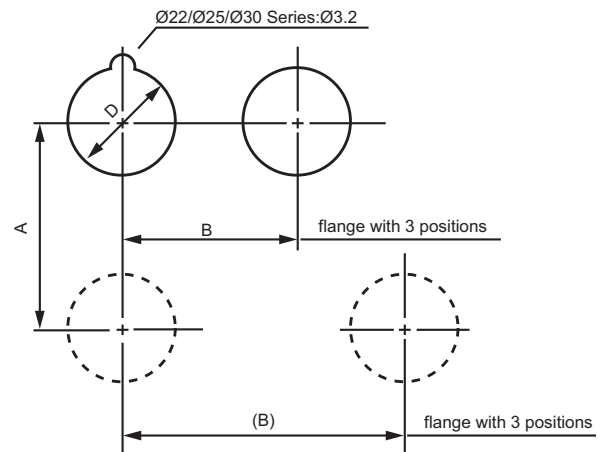

形狀、材質、顏色

R9系列產品包含3種不同型式

- 的組合
- 圓形22m/m, 用尼龍加纖維及
- 防火材料鍍銀銘設計
- 圓形30m/m, 用灰色尼龍加纖
- 維及防火材料
- 方圓形22m/m, 用灰色尼龍加纖維及防火材料

這優雅、現代、人性化的R9產品有多種顏色和款式可供選擇，同時也是高級工業設計經驗的結晶。



安裝方式

R9生產線提供多種產品、接點、電源供應器。在“易組合”的方式下，它們是全部可以相互交換的，且由於創新的凸緣設計，可使組裝的時間減到最少，不僅滿足了特別的使用需求，而且產品、接點及電源供應器可另選做為盒子安裝使用。



背面的鎖扣和背面的安裝程序

使用一種特別的工具（鎖環螺旋板手）穿過鎖環，將R9產品從背面安裝至配電盤上，這些組件也可以用一支一字的螺絲起子組裝。



安裝和放在適當位置

根據IEC529，所有的R9產品都裝有一個U型防水油封，以確保能達到IP65等級防水、防油、防塵的標準，在產品主體上有一個定位卡榫，在鑽有鍵槽孔的面板上能給予正確的位置，這卡榫也可確保配電盤的穩固，在進行安裝及維護時能防止它旋轉，面板若無鍵槽孔時，可用一支一字螺絲起子把卡榫移除。

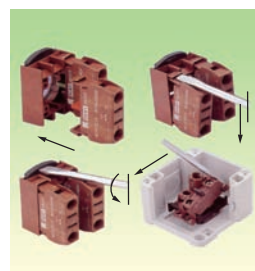

快速的裝置

全部R9系列的背面設計，是用插入扣上的，保證安裝快速。鉗上凸緣的獨特設計能牢固的安裝在產品上，如此可擔保各部份能迅速的結合，而對於盒子的安裝則是直接安裝在盒子內的卡座上。每一個單一組件都能分別的組合或移開，並不會妨礙其他部份。在配電盤的安裝方面，也可以將鉗上凸緣所扣在一起之組件安裝或移開，組件或凸緣能用一支標準的一字螺絲起子拆開，進行簡單的維護操作。



TYPE NUMBER NOMENCLATURE

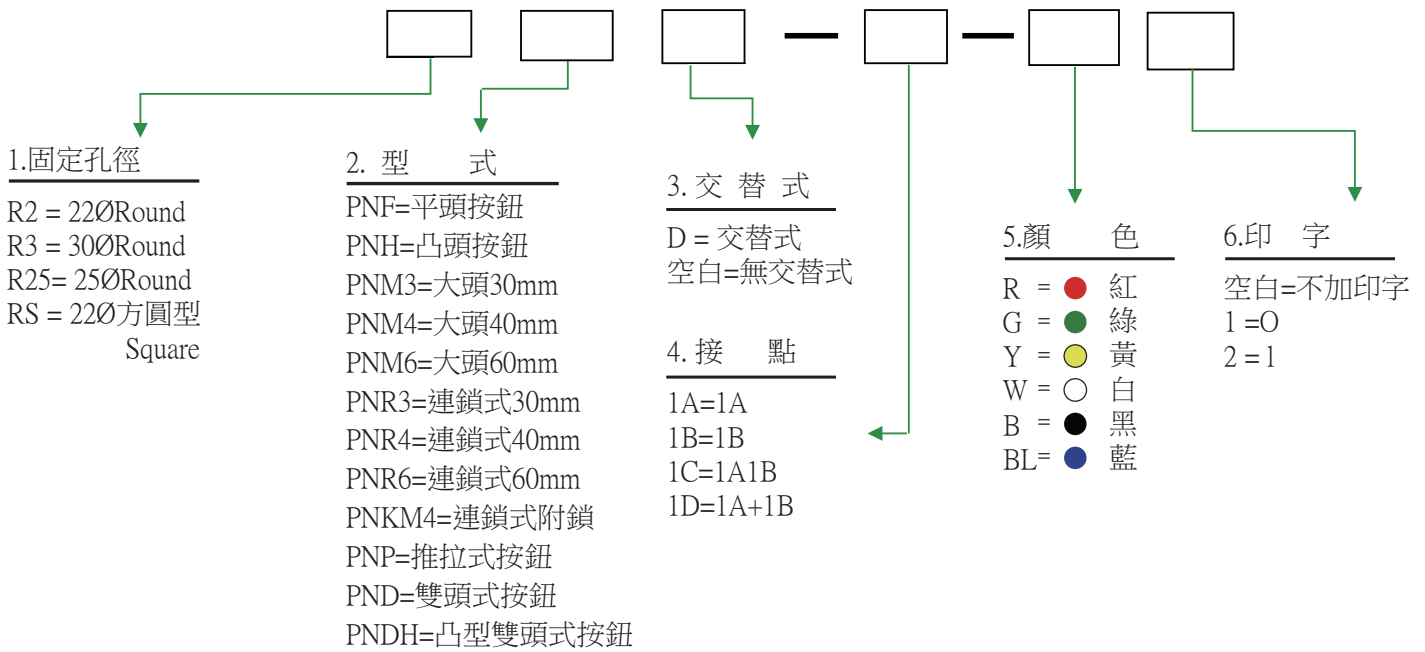

D=交替式

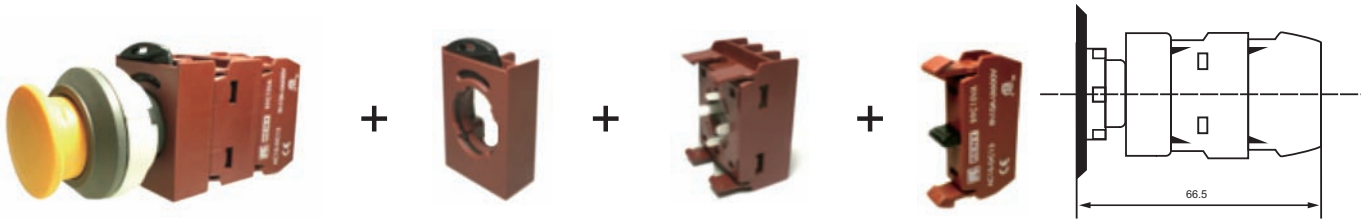

R2PNF

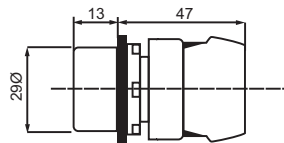

R3PNF

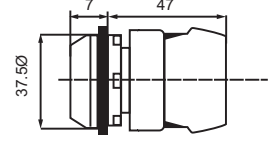

R2PNH

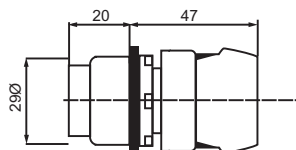

R3PNH

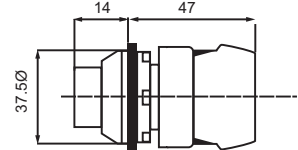

R2PNM3

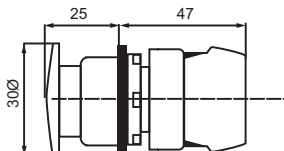

R3PNM3

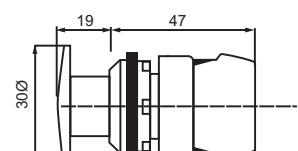

R2PNM4

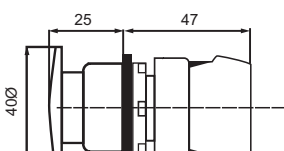

R3PNM4

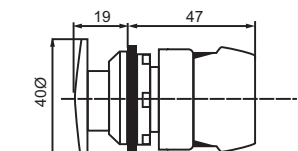

R2PNM6

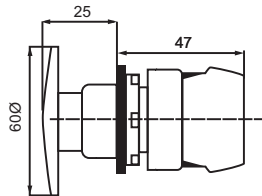

R3PNM6

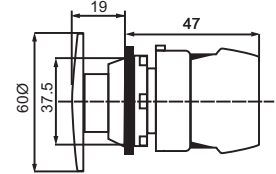

R2PNR3

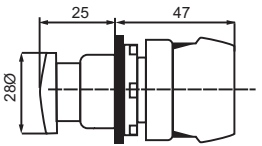

R3PNR3

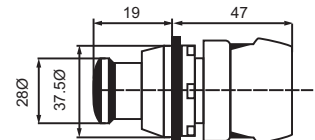

R2PNR4

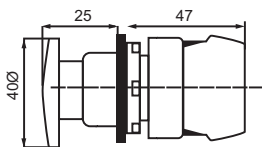

R3PNR4

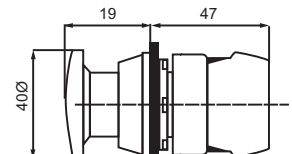

R2PNR6

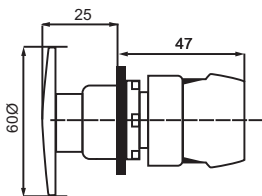

R3PNR6

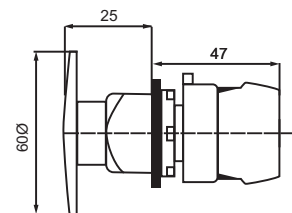

R2PNKM4

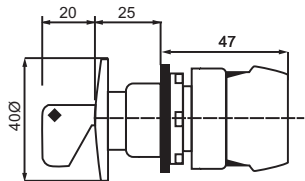

R3PNKM4

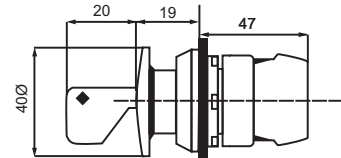

R2PND

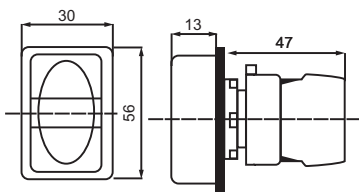

R2PNDH

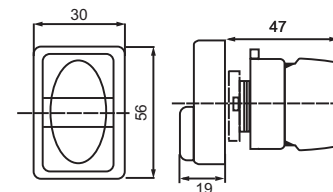

RSPNF

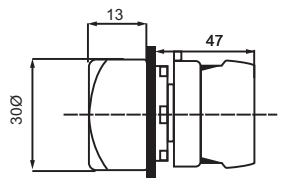

RSPNH

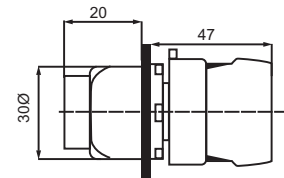

RSPNM3

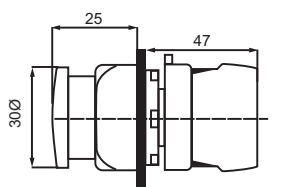

RSPNM4

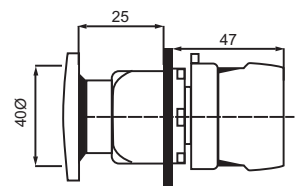

RSPNM6

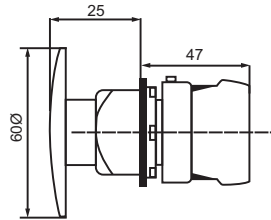

RSPNR3

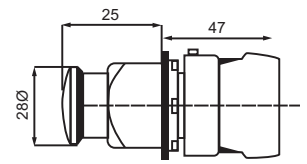

RSPNR4

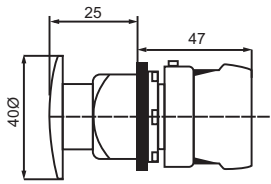

RSPNR6

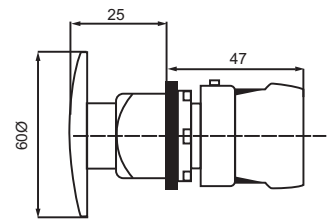

RSPNKM4

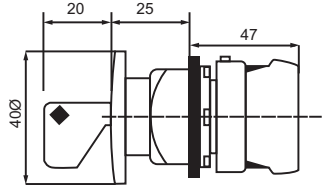
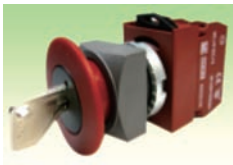

R2PNP

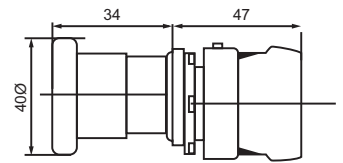

產品燈泡

IP65

TYPE NUMBER NOMENCLATURE

LED

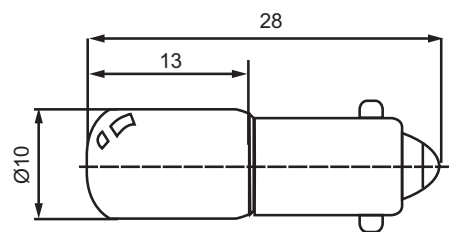
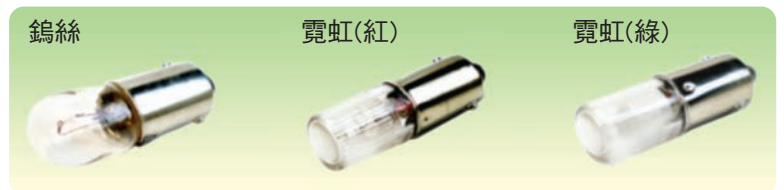
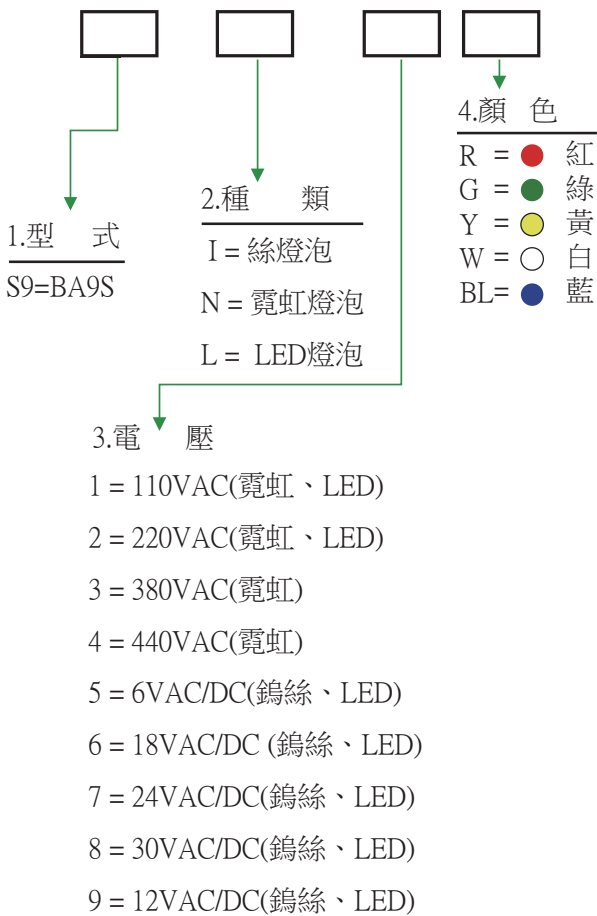



TYPE NUMBER NOMENCLATURE

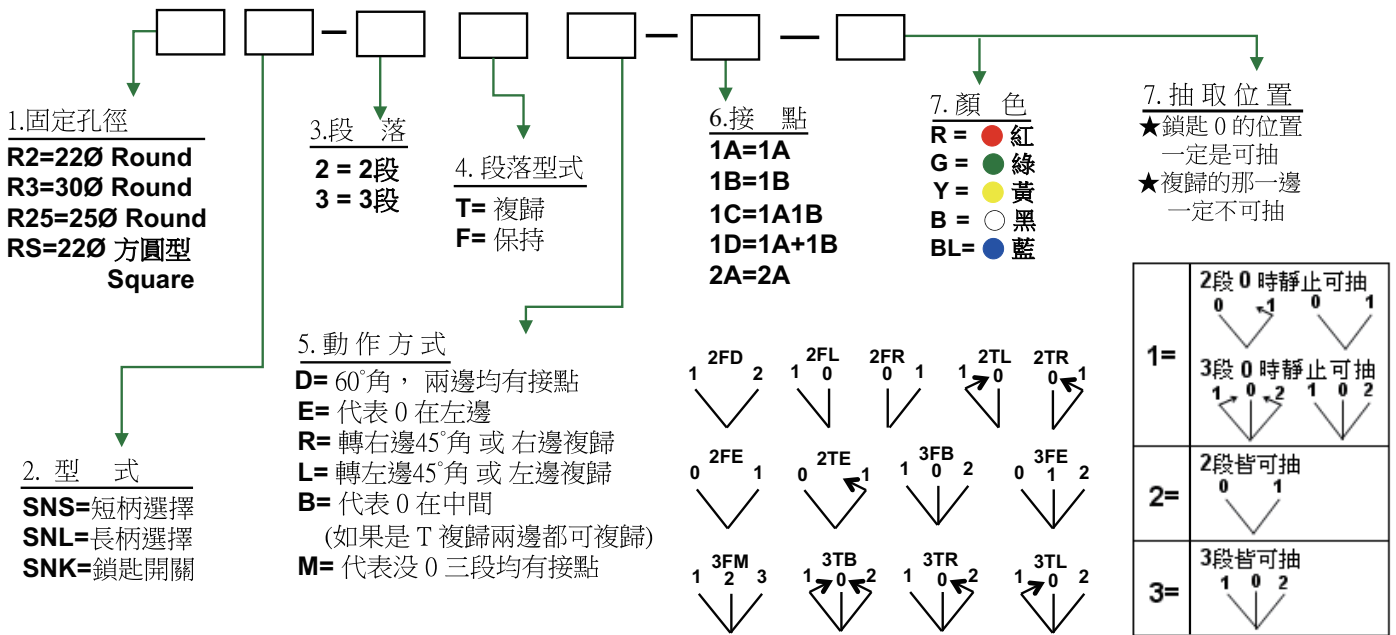

R2SNS

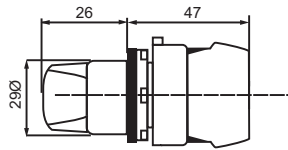

R3SNS

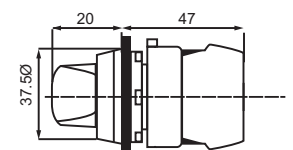

R2SNL

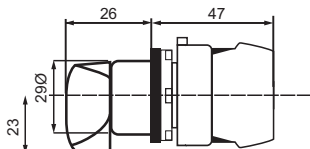

R3SNL

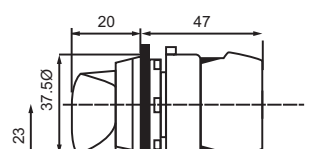

RSSNS

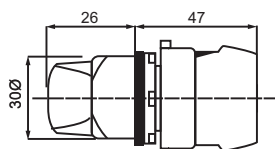

RSSNL

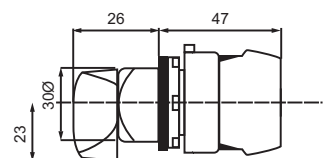

R2SNK

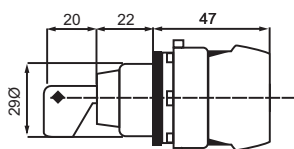

R3SNK

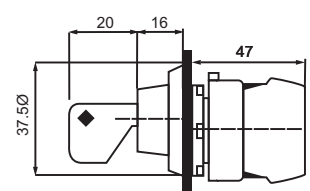

RSSNK

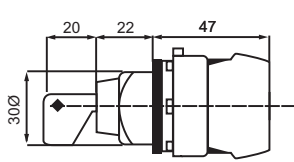



TYPE NUMBER NOMENCLATURE

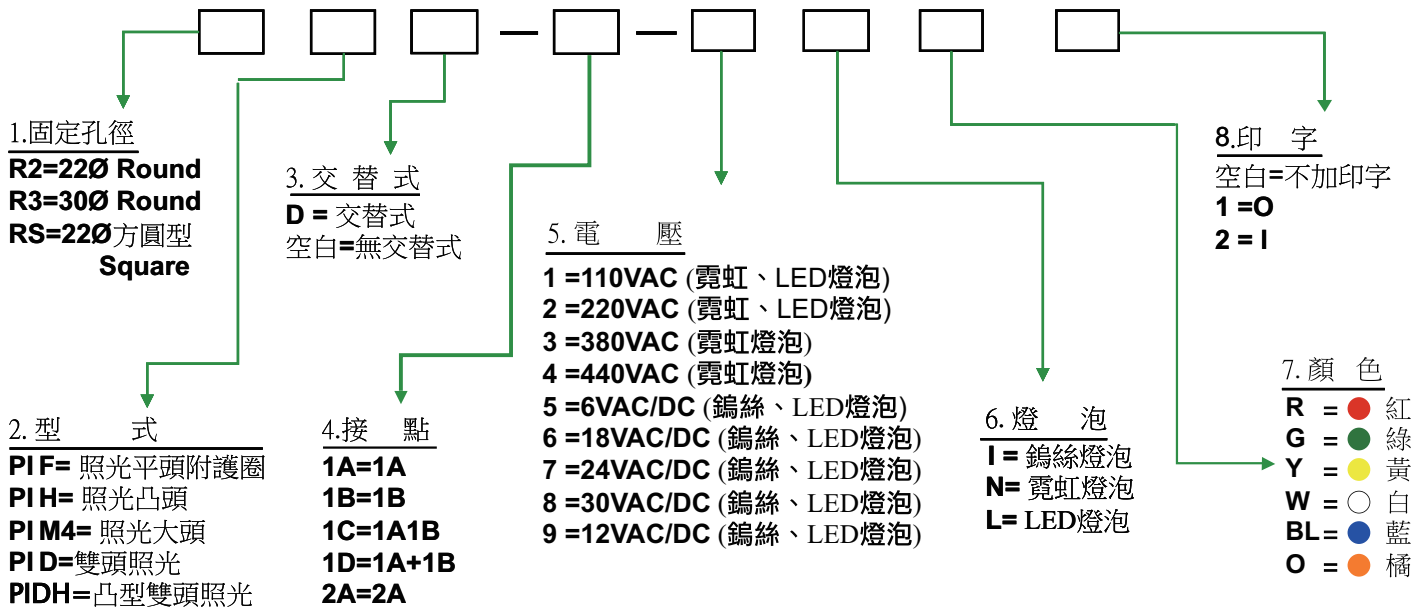

R2PIF

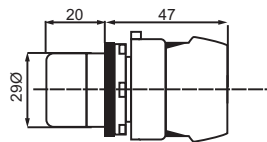

R3PIF

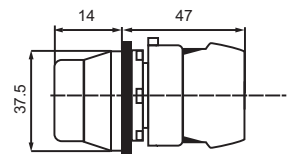

R2PIH

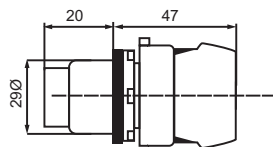

R3PIH

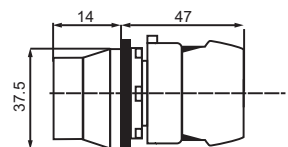

R2PIM4

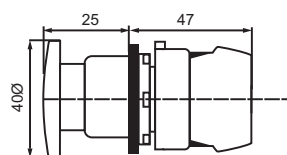

R3PIM4



R2PID

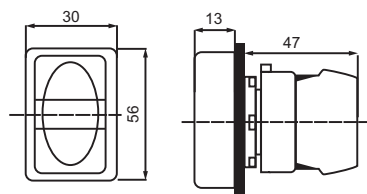

R2PIDH

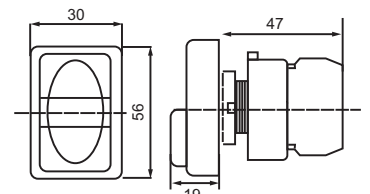

RSPIH

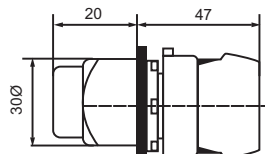

RSPIM4

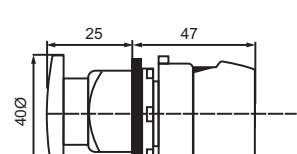



TYPE NUMBER NOMENCLATURE

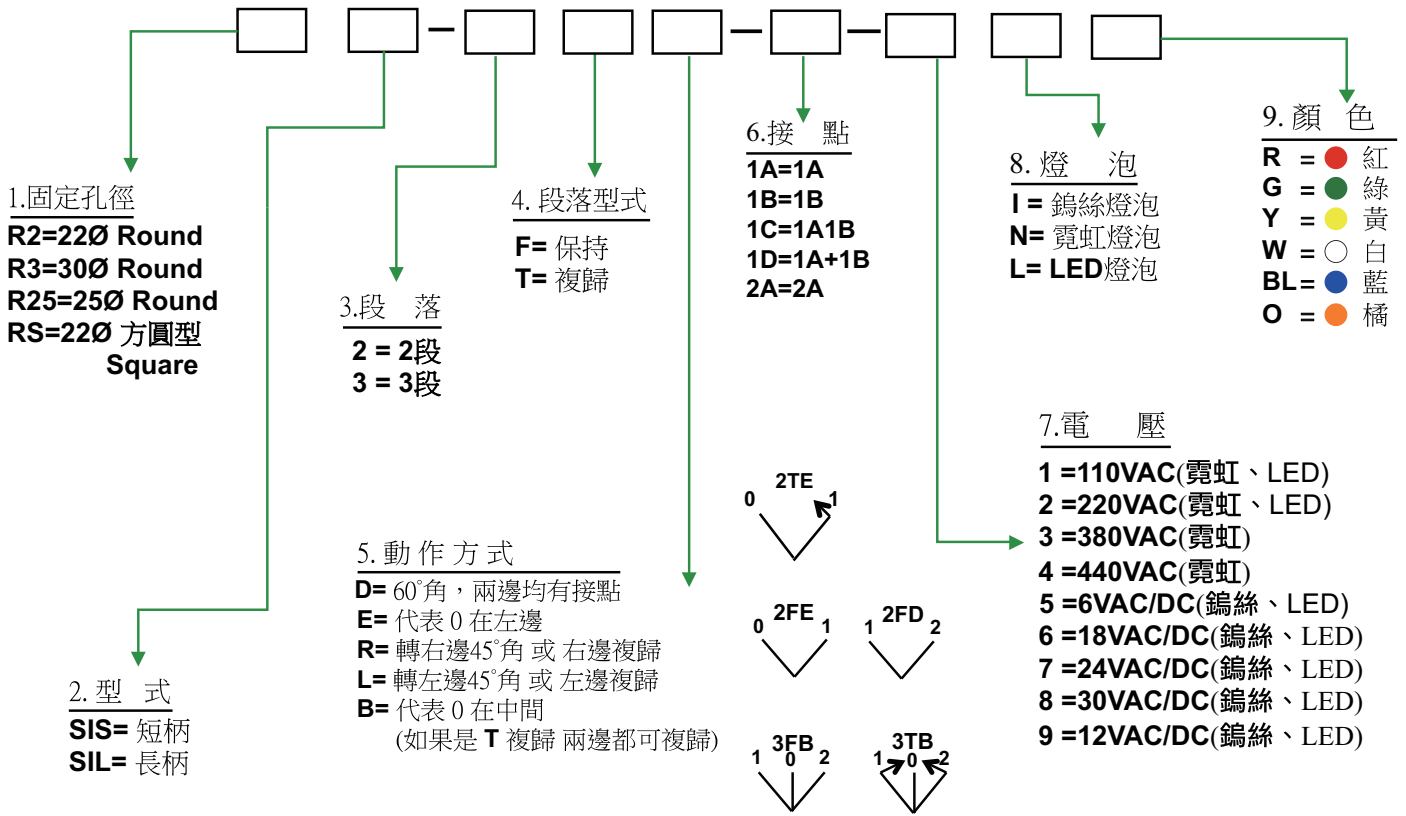

R2SIS

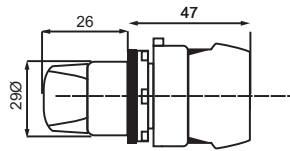

R3SIS

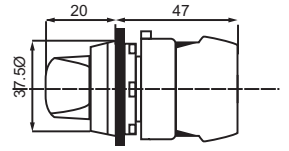

R2SIL

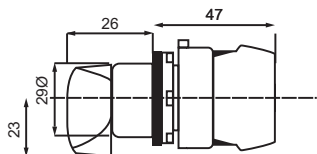

R3SIL

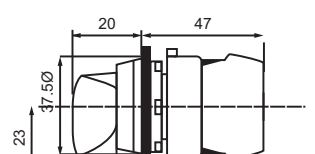

RSSIS

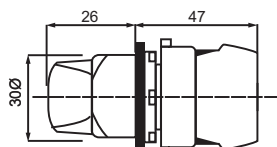

RSSIL

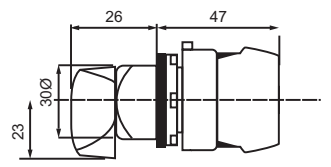



TYPE NUMBER NOMENCLATURE

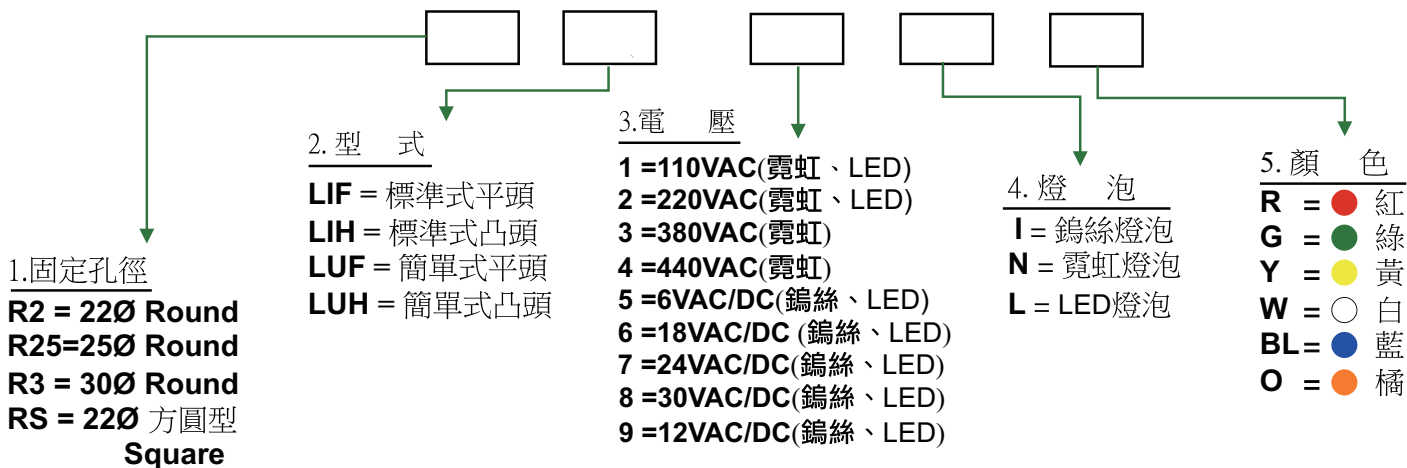

Signalling unit (Normal)

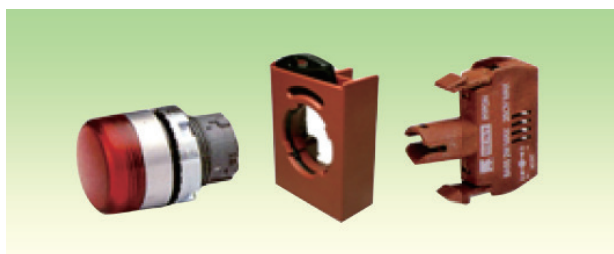

Signalling unit (Simple)

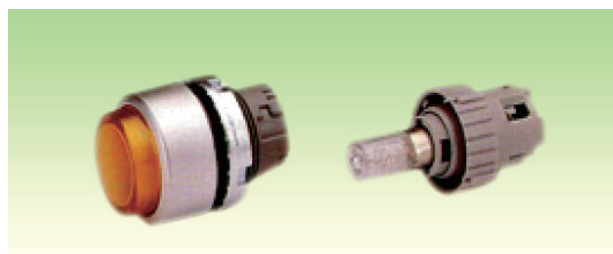

R2LIF



R3LIF

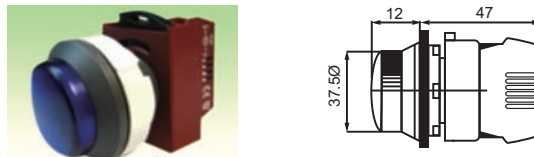

R2LIH

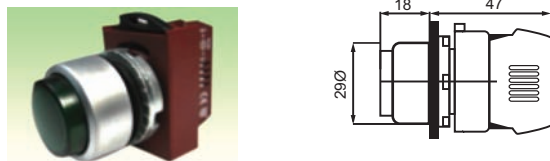

R3LIH



R2LUF



R3LUF



R2LUH



R3LUH



RSLUH



RSLIH

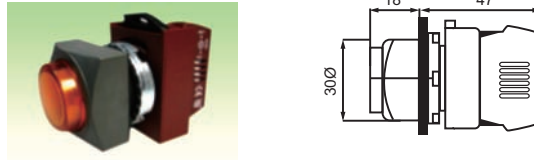



TYPE NUMBER NOMENCLATURE

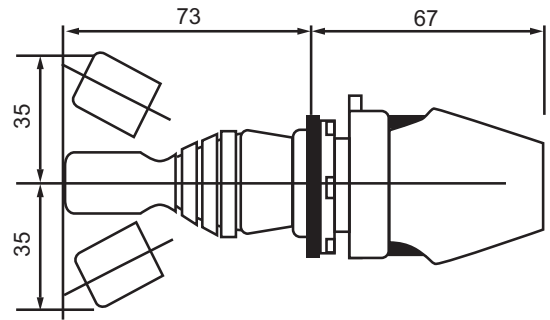
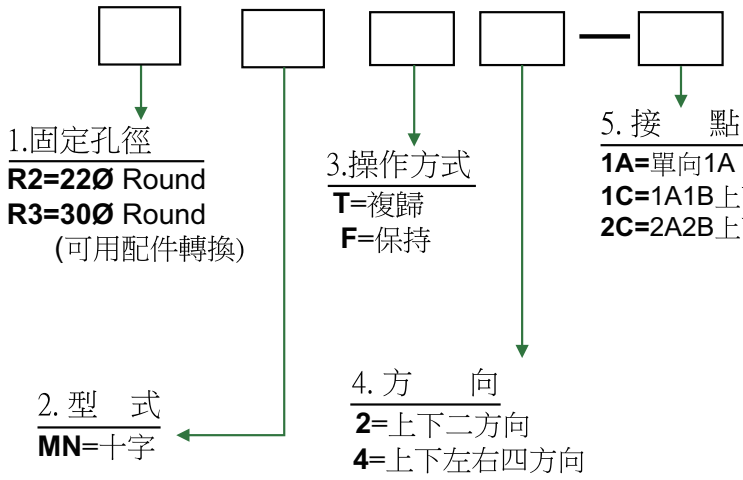

TYPE NUMBER NOMENCLATURE

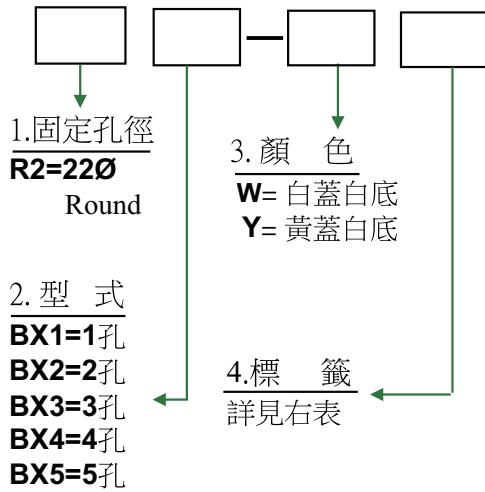

型式\尺寸	A	B	C	D	E	F	HxLxØmax
BX1	65	70	63	52	24	21.5	53x38x4.5
BX2	100	70	63	52	24	21.5	88x38x4.5
BX3	140	70	63	52	24	21.5	128x38x4.5
BX4	178	70	63	52	24	21.5	167x38x4.5
BX5		70	63	52	24	21.5	

B-01	B-02
B-03	B-04
ON OFF	ON OFF ON
B-05	B-06
STOP	START
B-07	B-08
EM.STOP	RESET

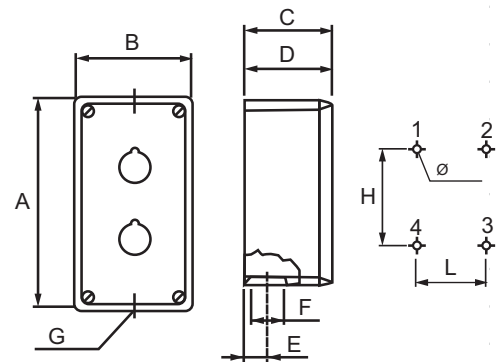



TYPE NUMBER NOMENCLATURE

Contact Blocks 接點組

接 點 圖

代號

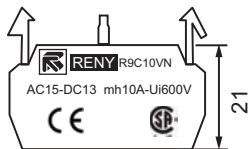
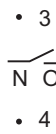

NO

R9C10VN

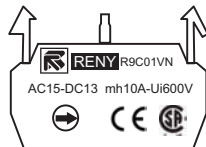

NC

R9C01VN

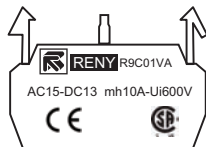

NO

R9C10VA

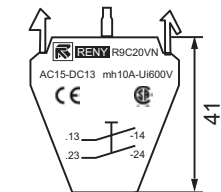

NO+NO

R9C20VN

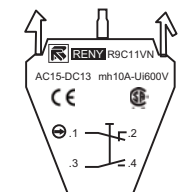
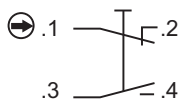

NO+NC

R9C11VN



IEC:BA9S max 380V-2W
CSA:BA9S max 250V-2W

R9PDNVS

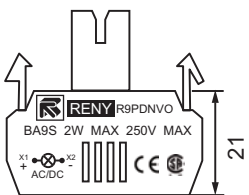

IEC:BA9S max 380V-2W
CSA:BA9S max 250V-2W

R9PDNVO

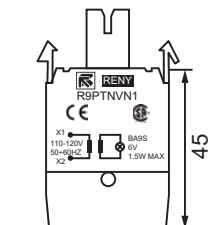
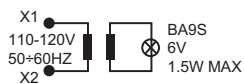

110 / 6V

R9PTNV1

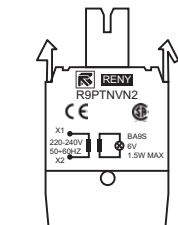
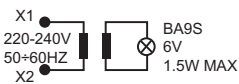

220 / 6V

R9PTNV2



產品配件

IP65

TYPE NUMBER NOMENCLATURE

Color Lens
色蓋

Type NO.訂購代號

Fill in the color code in □
(在□內填入顏色代號)

COMMON ACCESSORIES 配件

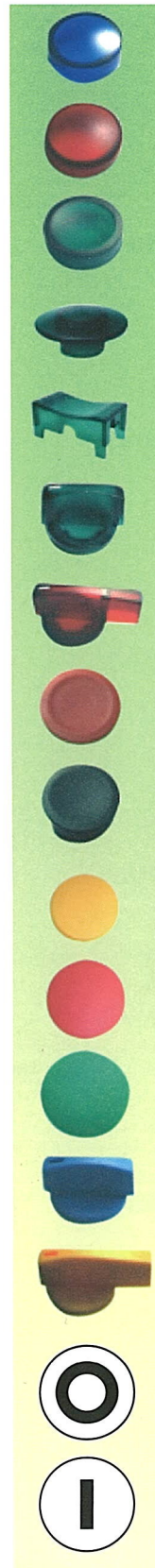

R9LRGH □代號

R.G.Y.W.BL

R9LRGF2 □代號
R9LRGF3 □代號

R.G.Y.W.BL

R9PRGF □代號

R.G.Y.W.BL

R9PRGM4 □代號

R.G.Y.BL

R9PSGD □代號

R.G.O.W

R9SRGS □代號

R.G.Y.W.BL

R9SRGL □代號

R.G.Y.W.BL

R9PRBF □代號

R.G.Y.
W.B.BL

R9PRBH □代號

R.G.Y.B.BL

R9PRBM3 □代號

R.G.Y.B.

R9PRBM4 □代號

R.G.Y.B.BL

R9PRBM6 □代號

R.G

R9SRBS □代號

R.G.Y.B.BL

R9SRBL □代號

R.G.Y.B.BL

R9PRGP- 0

色蓋及標示

R9PRGP- 1

色蓋及標示

Color :
R.G.Y.O.W.B.BL
R=Red(紅)
R=Green(綠)G
Y=Yellow(黃)Y

O=Orange(橘)O
W=Whiet(白)W
B=Black(黑)B
BL=Blue(藍)BL



R9FRS-H

R9FRS-L

R9FRB-H

R9FRB-L

R9TRM2

22Ø固定牙環

R9TRP2

25Ø固定牙環

R9TRP3

30Ø固定牙環

R9ACFS3

3P四角卡座

R9ACFS5

5P四角卡座

R2PRCF

平頭押扣矽膠防塵蓋

R2PRCH

凸頭押扣
凸頭照光 矽膠防塵蓋
平頭照光

R2PRCD

雙頭押扣防塵蓋

R9GRCF

PC平頭押扣保護蓋

R9GRM4

Ø40緊急開關保護蓋

R9ANK-1

鎖柄

-2

-3

R9TS

固定環工具把手