

集合燈 SP系列

30*30

40*40

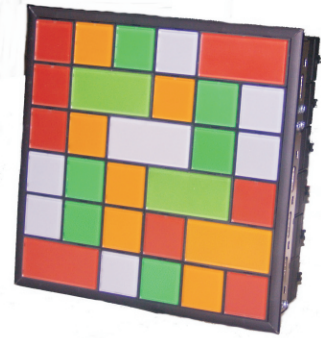
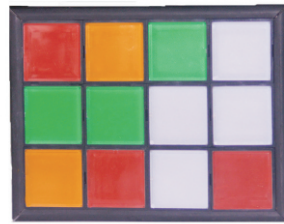
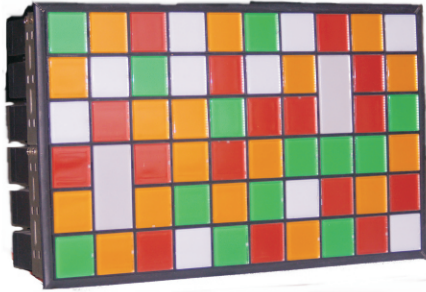

- 構造簡單可依需要自行搭配
- 多種燈泡組合，選擇多樣化
- 全電壓式，配線易



照光部尺寸	型號	類別		型號	電壓	型號	
H30*W30 H30*W60 H60*W30	3030	白熱燈泡	全電壓式	V	6VAC/DC	5	
					12V AC/DC	6	
					24V AC/DC	7	
		3060	LED燈泡	全電壓式	LB	30V AC/DC	8
						110V 50/60Hz	1
						220V 50/60Hz	2
	6030		附變壓器	附變壓器	LBT	6V AC/DC	5
						12V AC/DC	6
						24V AC/DC	7
		平面LED	全電壓式	全電壓式	L	110V 50/60Hz	1
						220V 50/60Hz	2
						220V AC/DC	2
H40*W40 H40*W80 H80*W40	4040		白熱燈泡	全電壓式	V	6VAC/DC	5
						12V AC/DC	6
						24V AC/DC	7
		4080	LED燈泡	全電壓式	LB	30V AC/DC	8
						6V AC/DC	5
						12V AC/DC	6
	8040		附變壓器	附變壓器	L	24V AC/DC	7
						110V 50/60Hz	1
						220V 50/60Hz	2
		平面LED	全電壓式	全電壓式	L	220V AC/DC	2
						6V AC/DC	5
						12V AC/DC	6
220V AC/DC	全電壓式		全電壓式	L	24V AC/DC	7	
					110V AC/DC	1	
					220V AC/DC	2	



項目	SP3030V SP3060V SP6030V SP4040V SP4080V SP8040V	SP3030LB SP3060LB SP6030LB SP4040LB SP4080LB SP8040LB	SP3030L SP3060L SP6030L SP4040L SP4080L SP8040L	SP3030VT SP3060VT SP6030VT	SP3030LBT SP3060LBT SP6030LBT
標準使用環境	週圍溫度-5~40℃ 相對濕度45~85% 高度2000m以下				
保護等級	IP40				
絕緣電壓	250V				
使用電壓	MAX AC/DC 30V	MAX AC/DC 110V	MAX AC/DC 30V MAX AC/DC 220V (加長型)	110 50/60Hz 220 50/60Hz 二次電壓6V	
燈泡類型	BAS9(白熱)	BAS9(LED)	平面LED	6V-1W(白熱) BAS9	6V-0.1W(LED) BAS9
端子強度	0.8N.m 15sec				
溫昇	40K以下(透明蓋表面和端子)				
絕緣阻抗	500V-100MΩ 以上				
耐電壓	AC 2000V 1min				
耐衝擊	490m/s ²				
耐振動	10~55Hz 複振幅0.35mm				

● 構造

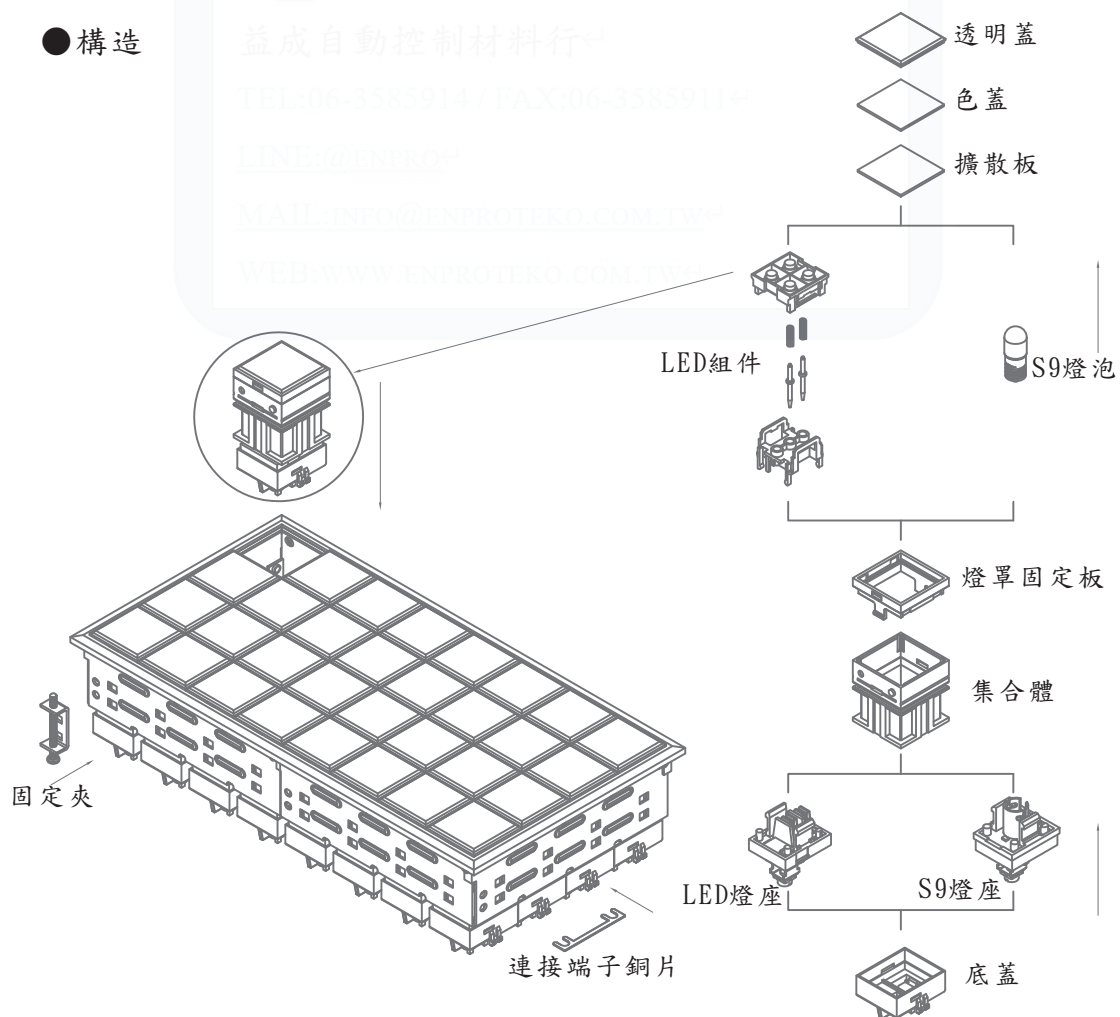

集合燈 SP系列

● 前視尺寸

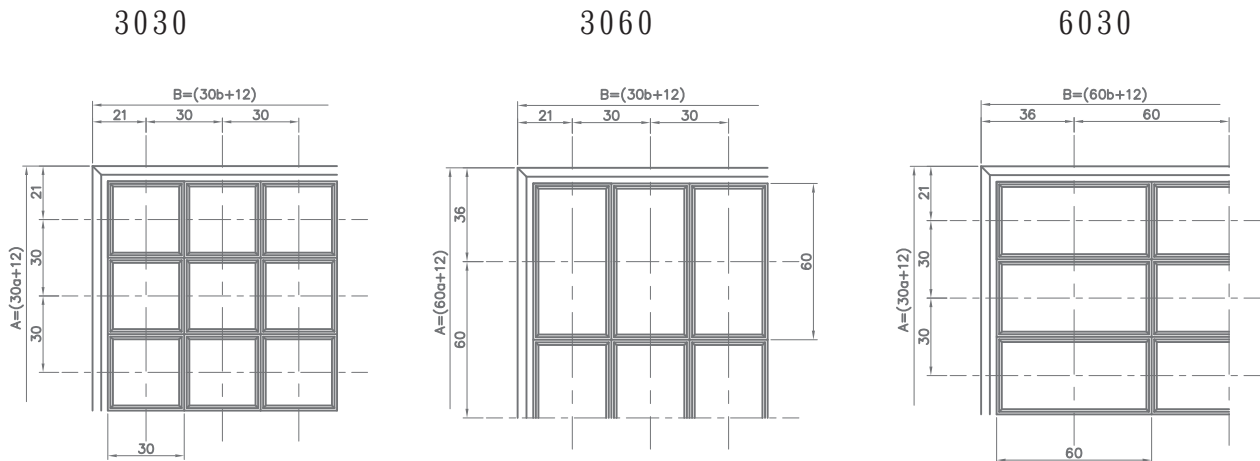

● 後視尺寸

● 開孔尺寸

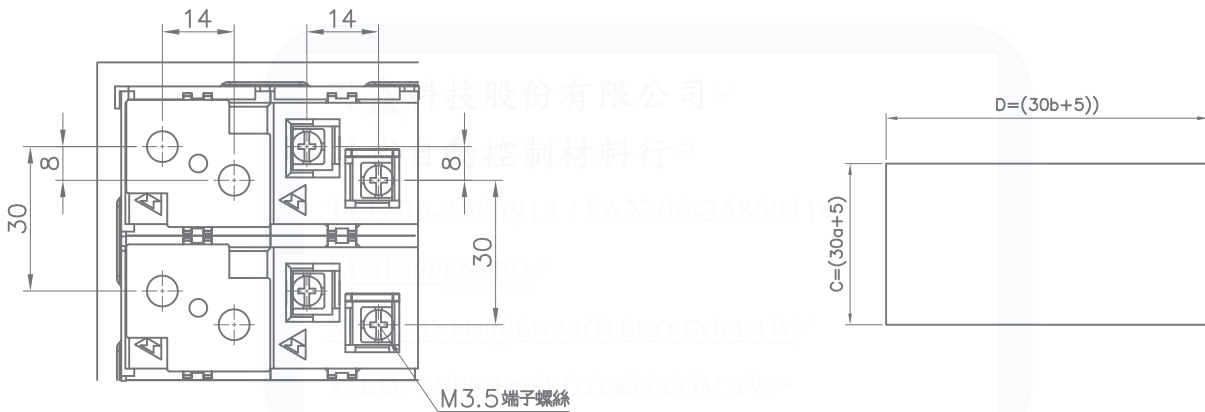

Columns	Rows																						
	b	01	02	03	04	05	06	07	08	09	10	11	12	13	14	15	16	17	18	19	20		
a	A	C	D	35	65	95	125	155	185	215	245	275	305	335	365	395	425	455	485	515	545	575	605
01	42	35	1	2	3	4	5	6	7	8	9	10	11	12	13	14	15	16	17	18	19	20	
02	72	65	2	4	6	8	10	12	14	16	18	20	22	24	26	28	30	32	34	36	38	40	
03	102	95	3	6	9	12	15	18	21	24	27	30	33	36	39	42	45	48	51	54	57	60	
04	132	125	4	8	12	16	20	24	28	32	36	40	44	48	52	56	60	64	68	72	76	80	
05	162	155	5	10	15	20	25	30	35	40	45	50	55	60	65	70	75	80	85	90	95	100	
06	192	185	6	12	18	24	30	36	42	48	54	60	66	72	78	84	90	96	102	108	114	120	
07	222	215	7	14	21	28	35	42	49	56	63	70	77	84	91	98	105	112	119	126	133	140	
08	252	245	8	16	24	32	40	48	56	64	72	80	88	96	104	112	120	128	136	144	152	160	
09	282	275	9	18	27	36	45	54	63	72	81	90	99	108	117	126	135	144	153	162	171	180	
10	312	305	10	20	30	40	50	60	70	80	90	100	110	120	130	140	150	160	170	180	190	200	

●側邊尺寸

通用型

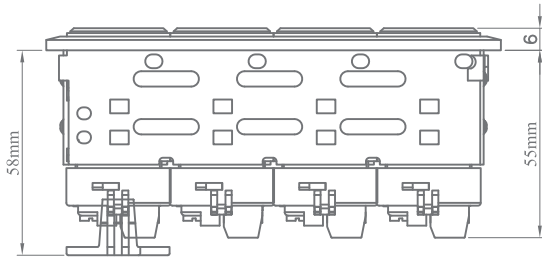

*白熱燈泡最高範圍為30V 1.2W
LED 組件型

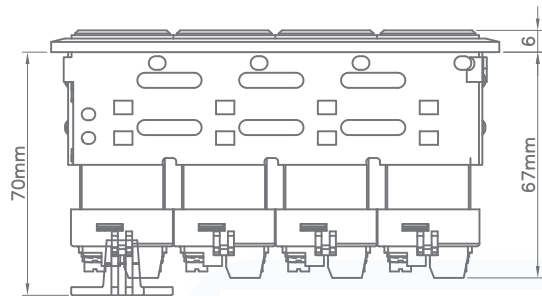

燈泡型(附變壓器)

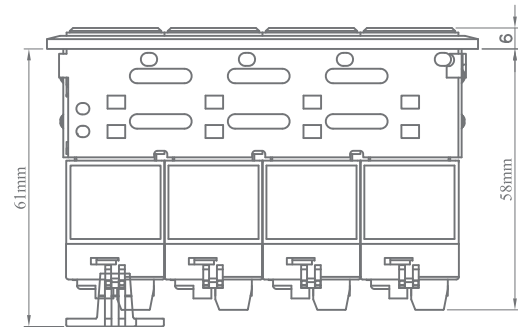

*用於110/220V

可鑫科技股份有限公司
益成自動控制材料行
TEL:06-3585914 / FAX:06-35859119
LINE:@enpro



● 前視尺寸

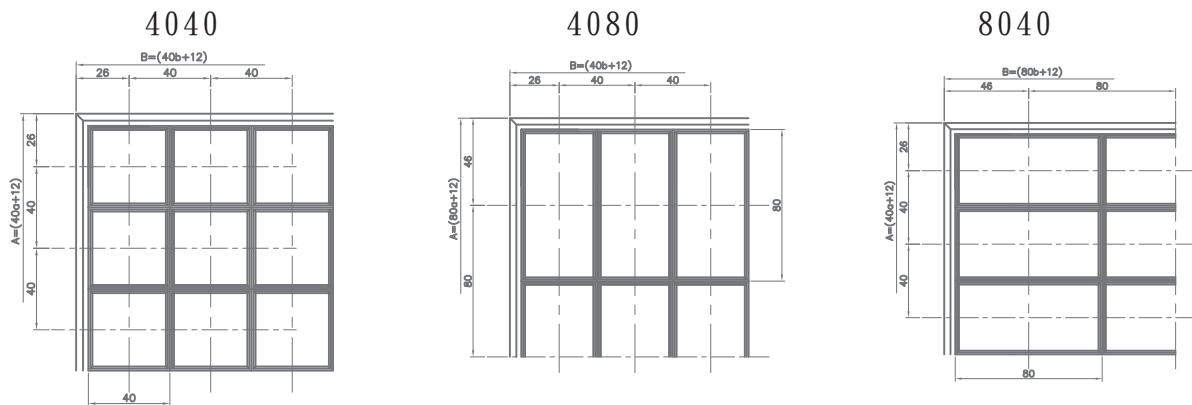

● 後視尺寸

● 開孔尺寸

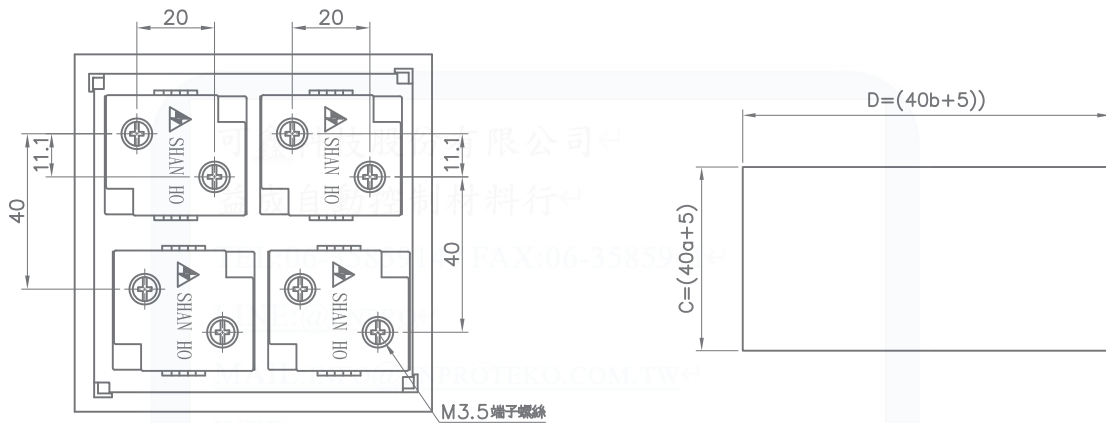

Rows	Columns																	
	b	01	02	03	04	05	06	07	08	09	10	11	12	13	14	15		
	B	56	96	136	176	216	256	296	336	376	416	456	496	536	576	616		
a	A	C	D	45	85	125	165	205	245	285	325	365	405	445	485	525	565	605
01	56	45	1	2	3	4	5	6	7	8	9	10	11	12	13	14	15	
02	96	85	2	4	6	8	10	12	14	16	18	20	22	24	26	28	30	
03	136	125	3	6	9	12	15	18	21	24	27	30	33	36	39	42	45	
04	176	165	4	8	12	16	20	24	28	32	36	40	44	48	52	56	60	
05	216	205	5	10	15	20	25	30	35	40	45	50	55	60	65	70	75	
06	256	245	6	12	18	24	30	36	42	48	54	60	66	72	78	84	90	
07	296	285	7	14	21	28	35	42	49	56	63	70	77	84	91	98	105	

● 側邊尺寸

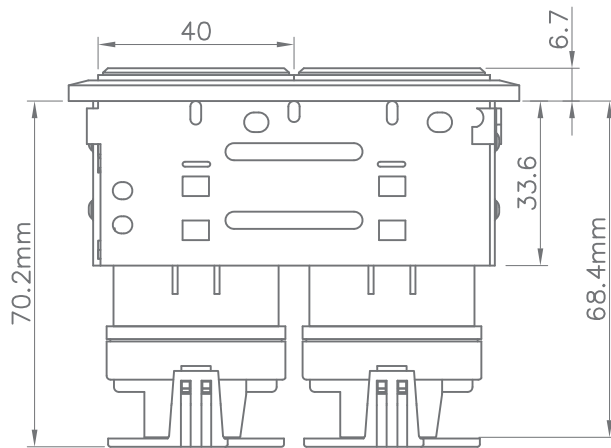

● 附件

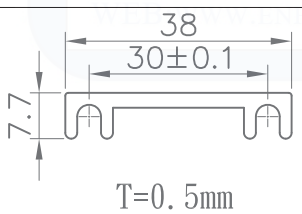
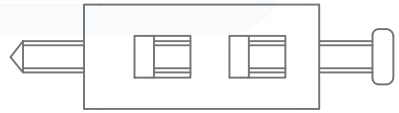
連接端子銅片 	固定夾 
---	---

● 燈泡樣式

LED組件 	LED 燈泡 	白熱燈泡 
--	---	---